



Smartbook

TIMBER SCREWS

**rothoblaas**

Solutions for Building Technology

THEORY

from page **5**

The right screw for the correct application

In order to guarantee the expected service life of connections and ensure adequate strength and durability, the screw selection must take into account its **resistance to corrosion**, the effect of **timber shrinkage and swelling** on its mechanical strength, its **behaviour in fire conditions** and the **material** on which it is installed.

CORROSION

from page **6**

SHRINKAGE and SWELLING

from page **24**

FIRE

from page **32**

APPLICATIONS and CONNECTORS

from page **46**

MATERIALS

from page **55**

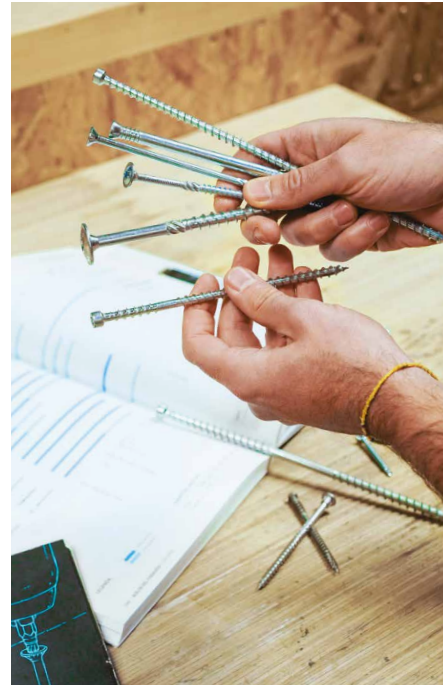

PRACTICAL

from page **57**

How to install correctly?

After choosing the screw, it is necessary **to install it correctly**, according to the type of joint in which it will be used, taking into account the **materials present** and using **suitable tools** for the type of application.

MINIMUM DISTANCES and PRE-DRILL

from page **58**

INSERTION MOMENT

from page **60**

TIMBER-TO-TIMBER

from page **62**

METAL-TO-TIMBER

from page **63**

SCREWDRIVERS

from page **70**

The right screw
for the correct
application



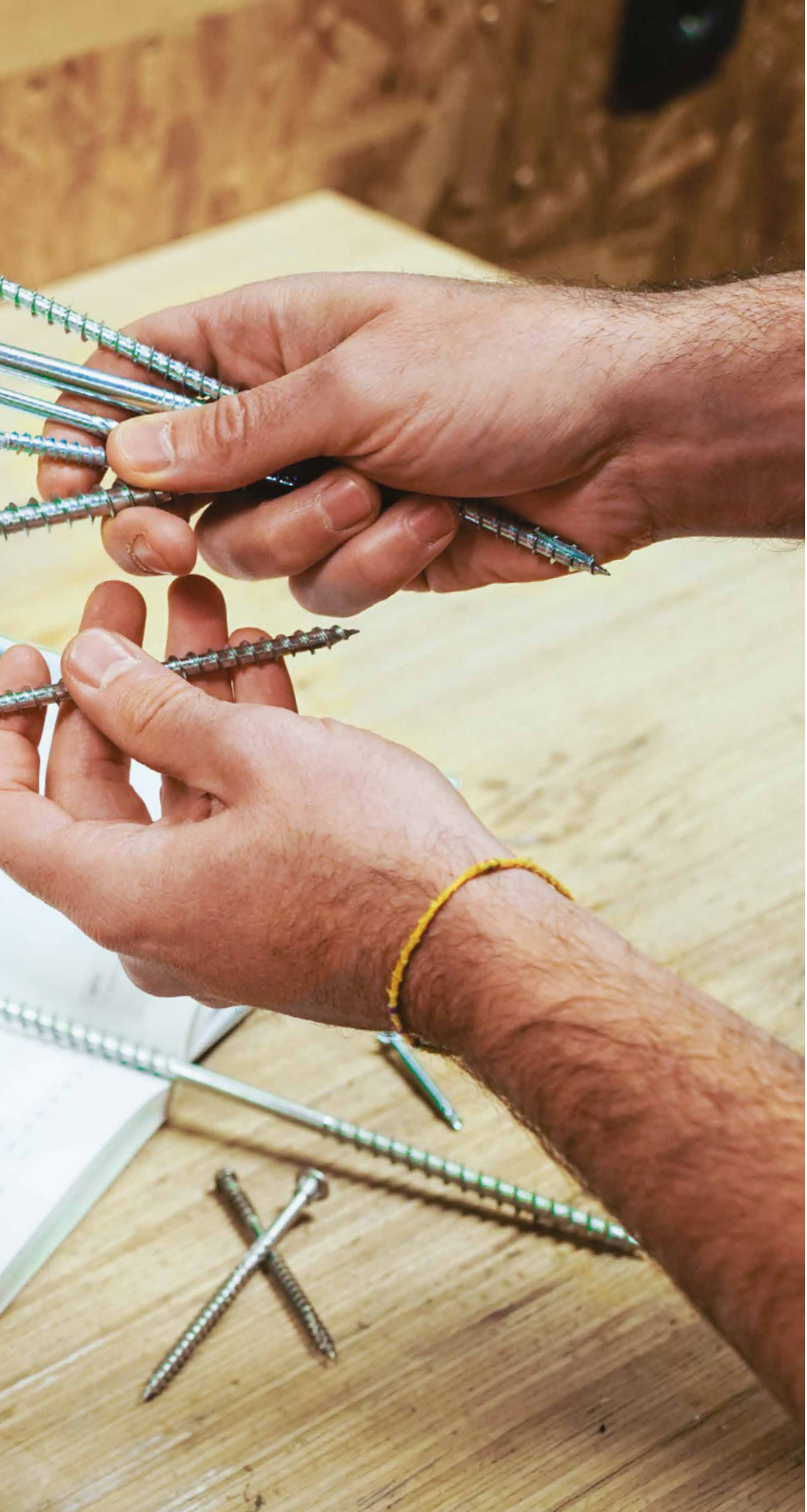

THEORY

CORROSION

ATMOSPHERIC CORROSIVITY CLASSES

INFLUENCING FACTORS

Corrosion caused by the atmosphere depends on relative humidity, air pollution, chloride content and whether the connection is internal, external protected or external. Exposure is described by the C_E category which is based on category C as defined in EN ISO 9223.

Atmospheric corrosivity only affects the exposed part of the connector.

C



presence of chlorides



pollution

SERVICE CLASSES

INFLUENCING FACTORS

The service classes are related to the thermo-hygrometric conditions of the environment in which a timber structural element is installed. They relate the temperature and humidity of the surroundings to the water content within the material.

SC



exposure



level of humidity

WOOD CORROSIVITY CLASSES

INFLUENCING FACTORS

Corrosion caused by wood depends on the wood species, wood treatment and moisture content. Exposure is defined by the T_E category as indicated.

The corrosivity of wood only affects the connector part inserted in the wooden element.

T



pH of the wood



moisture content of the wood

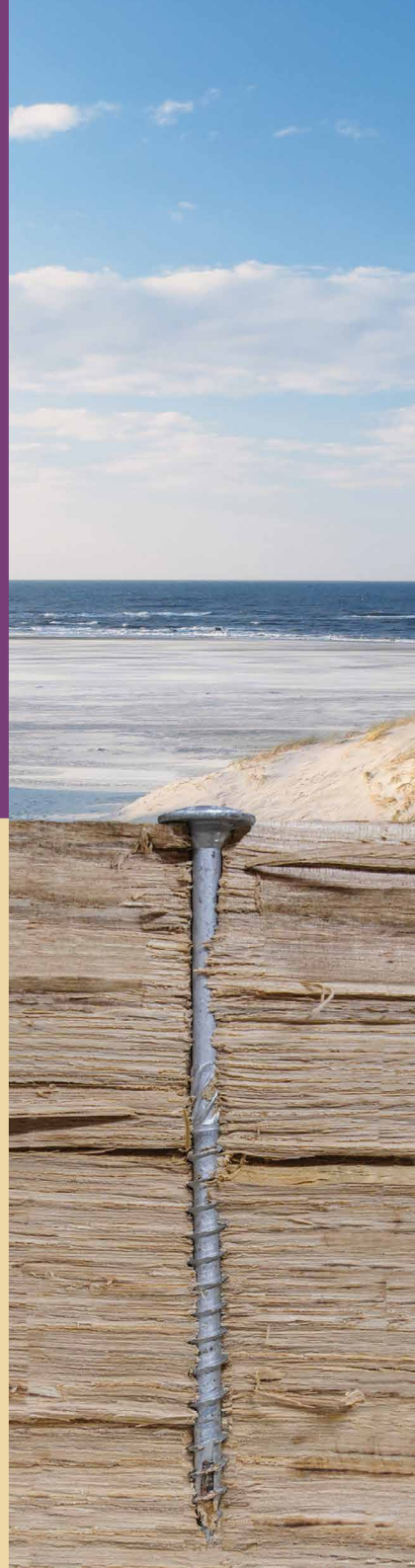

SERVICE CLASSES - SC

[Defined according to the new generation of Eurocode 5 (prEN 1995-1-1)⁽⁶⁾]



EXPOSURE

most common cases

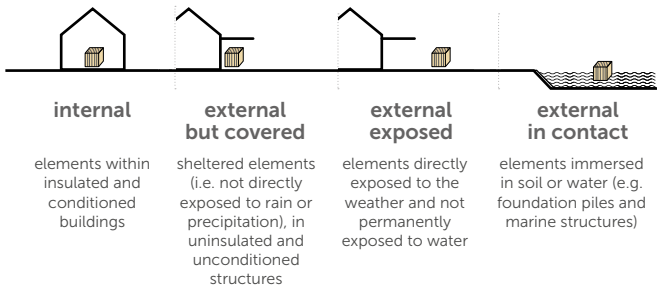

RELATIVE HUMIDITY AND EQUILIBRIUM MOISTURE CONTENT OF THE WOOD

Annual average⁽²⁾

relative atmospheric humidity of the surrounding air



50%

75%

85%

⁽³⁾

corresponding wood moisture content⁽⁴⁾⁽⁵⁾



(10%)

(16%)

(18%)

saturated

Maximum⁽¹⁾

relative atmospheric humidity of the surrounding air



65%

85%

95%

⁽³⁾

corresponding wood moisture content⁽⁴⁾⁽⁵⁾



(12%)

(20%)

(24%)

saturated

⁽¹⁾ The upper limit of relative humidity must not be exceeded for more than a several consecutive weeks per year.

⁽²⁾ The average annual relative humidity over a ten-year period is used to assign wood elements to the corrosivity categories for dowel type fasteners.

⁽³⁾ The moisture content of members in SC4 (primarily fully saturated) is affected by the surrounding element (e.g. soil or water).

⁽⁴⁾ The moisture content may not apply to engineered wood products, LVL or wood-based panel products.

⁽⁵⁾ Corresponding representative moisture of SWB (Solid Wood Based) elements.

⁽⁶⁾ prEN 1995-1-1 (n.d.) Basis of design and materials - Final draft (22.01.2021) - Project team SC5.T3 & SC5/WG10, CEN.

ATMOSPHERIC CORROSIVITY CLASSES - C

[Defined according to EN 14592:2022 based on EN ISO 9223]

ENVIRONMENT

C1



C2



MOISTURE



rare condensation



rare condensation

EXPOSURE TO CHLORIDE

deposit rate of chloride
[mg/m²d]

> 10 km
6.2 mi
from the coast
≤ 3



EXPOSURE TO POLLUTANTS

level of pollution
sulphur dioxide content
[µg/m³]

very low
about 0

low
< 5



deserts, central arctic/antarctic



rural areas with little pollution,
small towns

C3



C4



C5



occasional condensation



frequent condensation



permanent condensation

from 10 to 3 km
6.2 to 1.9 mi
from the coast
from 3 to 60

from 3 to 0,25 km
1.9 mi to 820 ft
from the coast
from 60 to 300

< 0,25 km
820 ft
from the coast
from 300 to 1500



from 10 to 100 m
35 to 325 ft

from 0 to 10 m
0 to 35 ft

from the road with antifreeze salts



medium
from 5 to 30

high
from 30 to 90

very high
from 90 to 250



urban and industrial areas with medium pollution

highly polluted urban and industrial area

environment with very high industrial pollution

WOOD CORROSIVITY CLASSES - T

[Defined according to EN 14592:2022]



WOOD SPECIES pH VALUE

Wood contains an acetic acid ester that acts as a corrosive agent for various metals in contact with wood. The presence of acetic acid determines the pH of the wood species



any



any

WOOD TREATMENT

Wood treatment includes treatment with chlorides, copper and flame retardants.

In the case of heat-treated wood, the pH level is decreased



untreated and treated wood



untreated and treated wood

MOISTURE CONTENT

Each timber exposure category corresponds, for solid wood, to the annual average moisture content in the indicated service class (as defined on page 7)

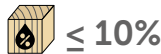

SERVICE CLASS

Of the environment in which the wooden element is installed

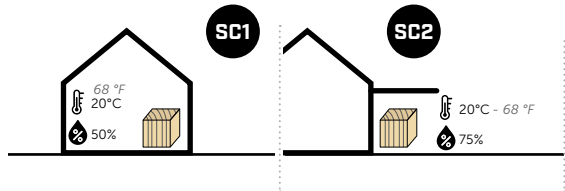

T3



pH > 4
"standard" timbers
low acidity

T4



pH ≤ 4
"aggressive" woods
high acidity

T5



any



only untreated
wood



untreated and treated
wood



untreated and treated
wood

16% <  ≤ 20%

 > 20%

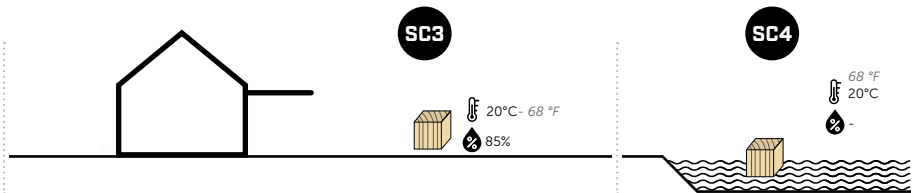

WOOD SPECIES and pH for T3 and T4

[Defined according to Wagenführ R; Wagenführ A. 2022. Holzatlas e Coatings for Display and Storage in Museums January 1999 Publisher: Canadian Conservation Institute Jean Tetreault]

The presence of acetic acid is particularly important when wood is directly exposed to weather (SC3). Knowing which wood species is more acidic is therefore crucial when evaluating the corrosion potential of fasteners and connectors.

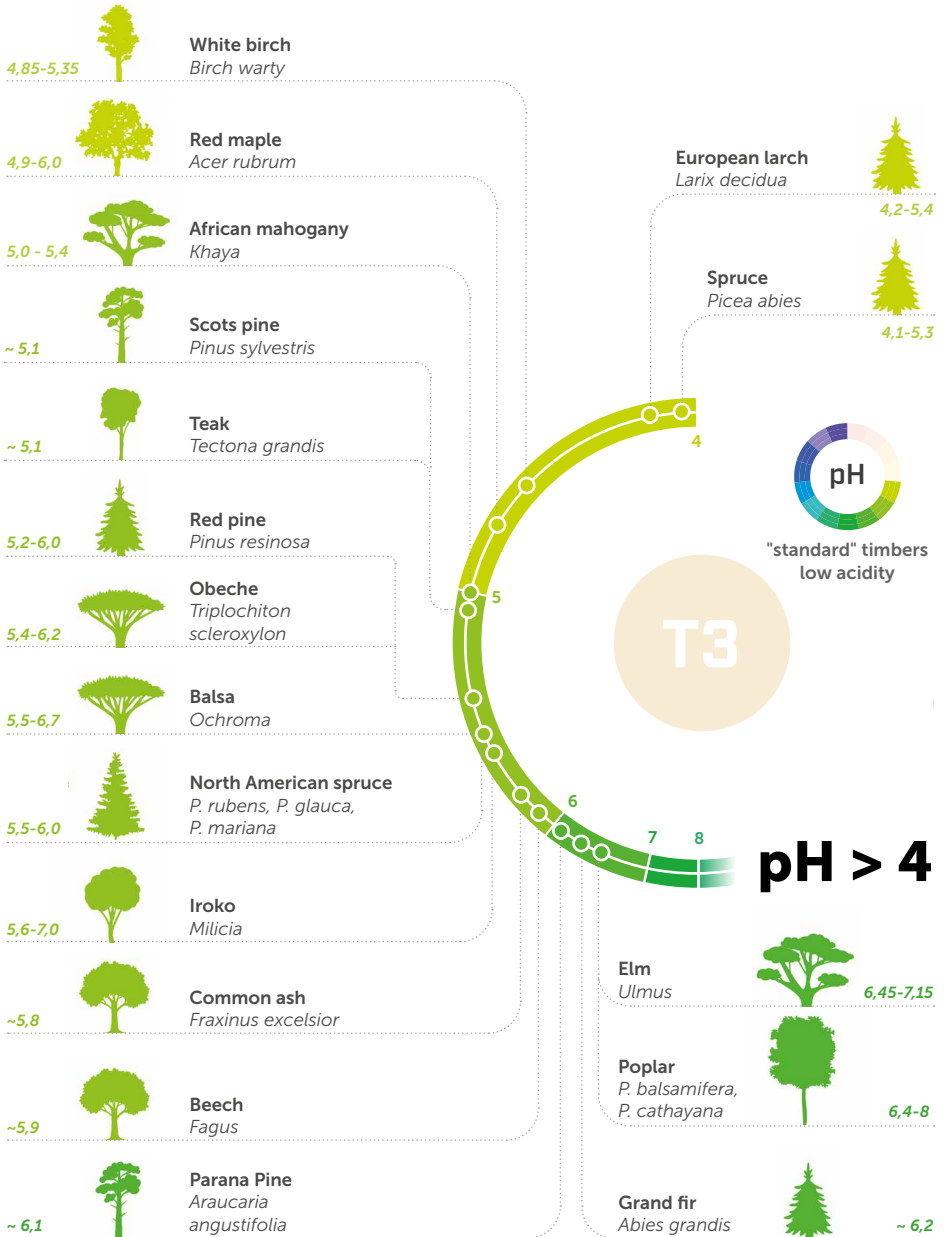

Which timbers are the most aggressive?
It depends on the pH!

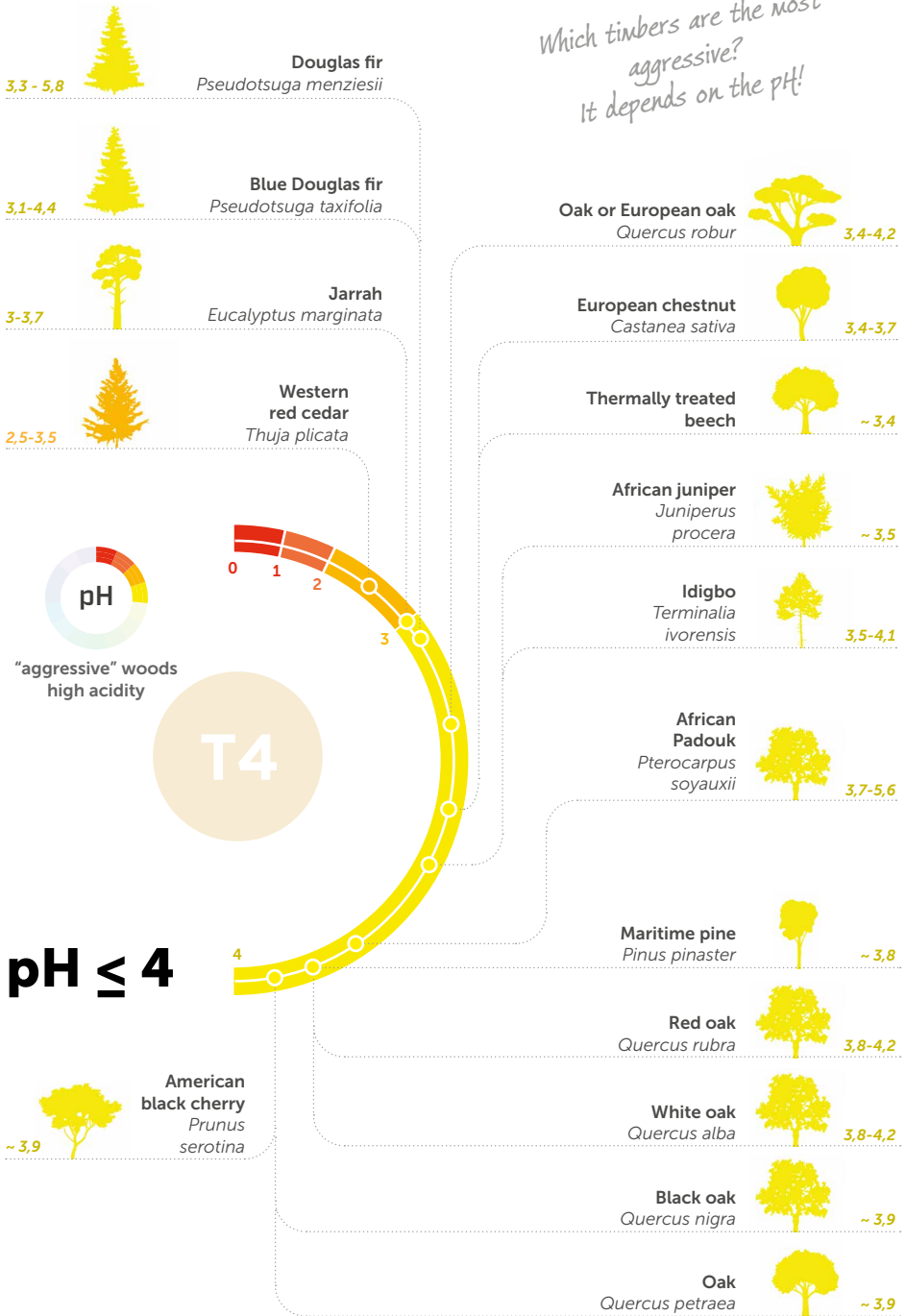

TANNINS and pH

Protection or corrosion?

Tannins are a chemical substance found in plant extracts, belonging to the polyphenol family, common in plants and trees. Their biological role is that of defence; they are molecules with antioxidant properties.

Their effect on metal, however, is contrary to what one would expect. In fact, as soon as the corrosion process begins, tannins adhere to the surface of the connector and form a **protective layer** that slows the corrosion rate. **The more tannins present in wood, the slower the corrosion of a connector once triggered.**

EFFECT OF TANNINS

connector:	fully threaded screw	
coating:	zinc plated ($\approx 10\mu\text{m}$)	
wood:	green oak	
exposure time:	6 months	
service class [SC]:	SC3	
atmospheric corrosivity classes [C]:	C2	
wood corrosivity class [T]:	T4	

- Tests carried out by R&D Rothoblaas have shown that, in just two months, the effect of the tannins is evident:
- ① On the part of the connector embedded deep into the wooden element, a substantial black protective layer can be seen.
 - ② Near the wood surface, the connector has corroded (red rust) because the protective layer has been washed away by water.

CORROSION RATE

Corrosion rate of Zn in wood extracts [$\mu\text{m}/\text{year}$] with varying pH and tannin content⁽¹⁾

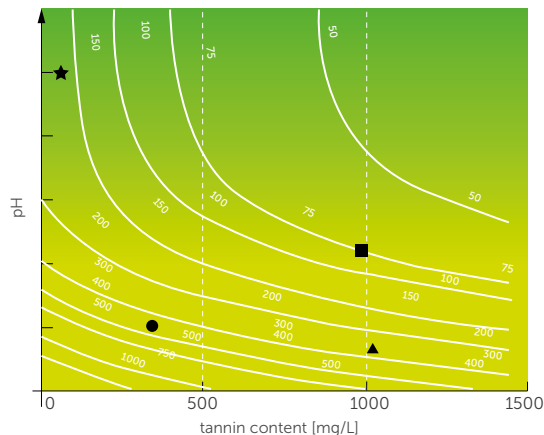

The most important factor to consider in the corrosion of embedded fasteners is the wood corrosivity class (T) related to pH and wood moisture. At the same pH level, the presence of tannins slows down the corrosive phenomenon.

We usually tend to associate tannins with corrosion because so many tannin-rich woods are also acidic ($\text{pH} < 4$). However, there are exceptions, such as *Martime pine* and *Douglas fir*, which are classified T4, although they have relatively low tannin content compared to other acidic wood species.

- ▲ oak
- pine
- acacia
- ★ elm

⁽¹⁾ Based on research by S. Zelinka, *Corrosion in Wood Products*. 2014. (Ed.), ISBN: 978-953-51-1223-5, InTech, DOI: 10.5772/57296.

EXPERIMENTAL TESTING

An experimental campaign was carried out at our laboratory to evaluate the corrosion trend of connectors over time.

During the tests, the following were analysed:

- about **350 configurations**
- obtained by combining **6 different types** of screws
- for a period of **1 year**

The specimens were placed in environments with **different service classes**.

The screws were extracted on a **monthly basis** to assess the corrosion rate and the influence of the different variables involved.



SET-UP:

wood:	oak
exposure time:	12 months
service class [SC]:	SC3
atmospheric corrosivity classes [C]:	C2
wood corrosivity class [T]:	T4

RESULTS:



after 1 month



after 10 month



STEEL AND COATINGS

The best compromise between corrosion resistance and mechanical strength

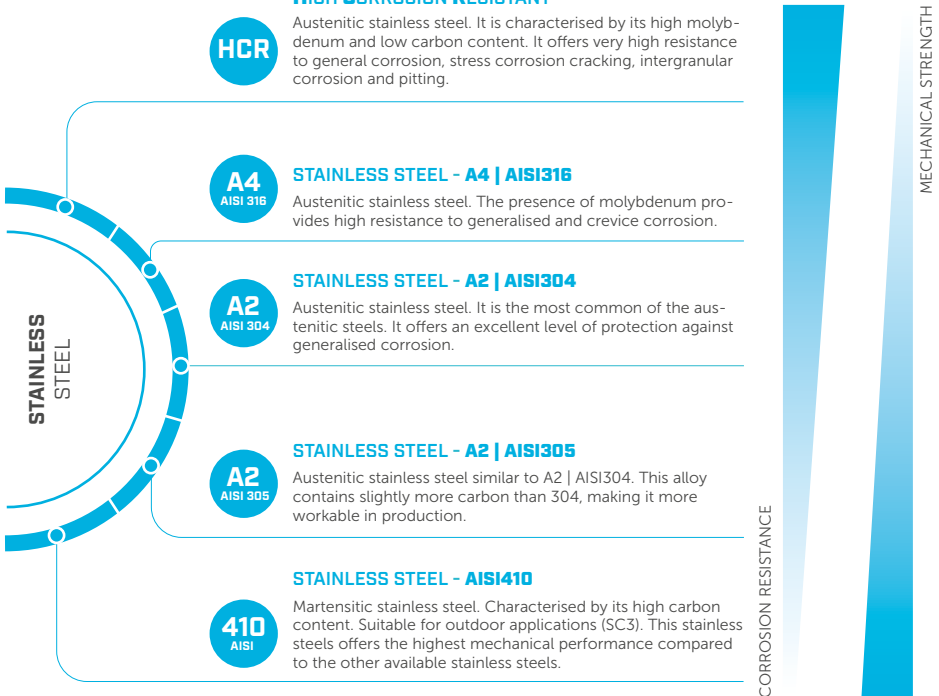
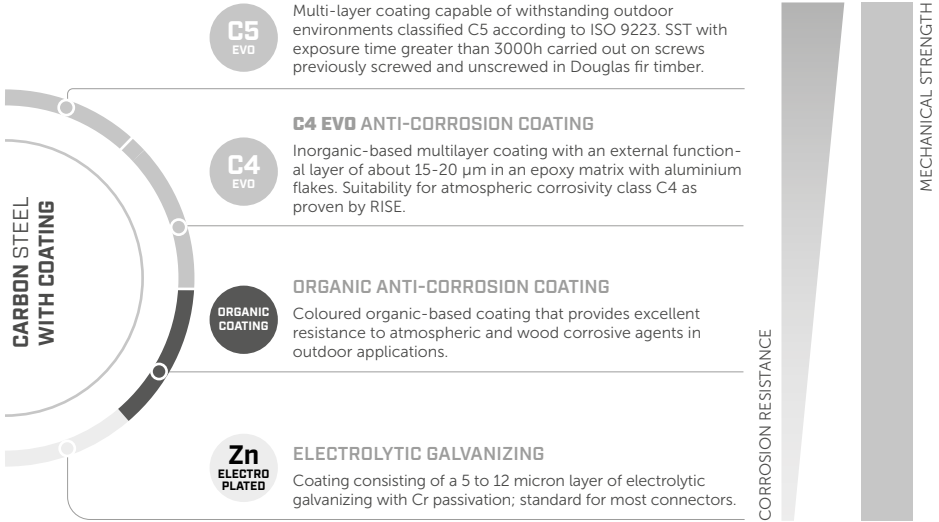

*Aesthetic and design requirements:
all range connectors*



HCR	A4 AISI316	A4 AISI316	A2 AISI304	C4 EVO		Zn ELECTRO PLATED	
SCI HCR	SCI A4	VGS A4	SCI A2	HBS EVO	VGS EVO	HBS	VGS

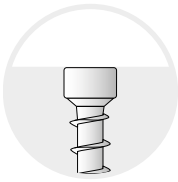

A2 AISI304		AISI410		C4 EVO	ORGANIC	Zn ELECTRO PLATED	
KKZ A2		KKA AISI410		VGZ EVO	KKAN	VGZ	

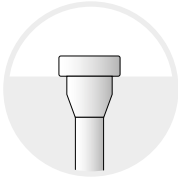

AISI410	A4 AISI316		C4 EVO		Zn ELECTRO PLATED	
KKF AISI410	HBS PLATE A4		HBS PLATE EVO		HBS PLATE	



A2 AISI304	AISI410	Zn ELECTRO PLATED		C4 EVO		Zn
SHS	SHS AISI410	HBS HARDWOOD		TBS EVO		TBS

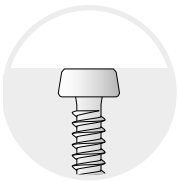
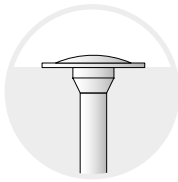

A4 AISI316		ORGANIC					A2 AISI304	AISI410
KKT A4		KKT					EWS A2	EWS AISI410



DISTANCE FROM THE SEA

RESISTANCE TO CHLORIDE EXPOSURE

What is the best material if I am near the sea?

Comparison of atmospheric corrosion resistance between different types of zinc coatings and different types of stainless steel used in screws for timber, considering only the influence of chlorides (salt) and without a cleaning cycle (based on EN 14592:2022 and EN 1993-1-4:2014).

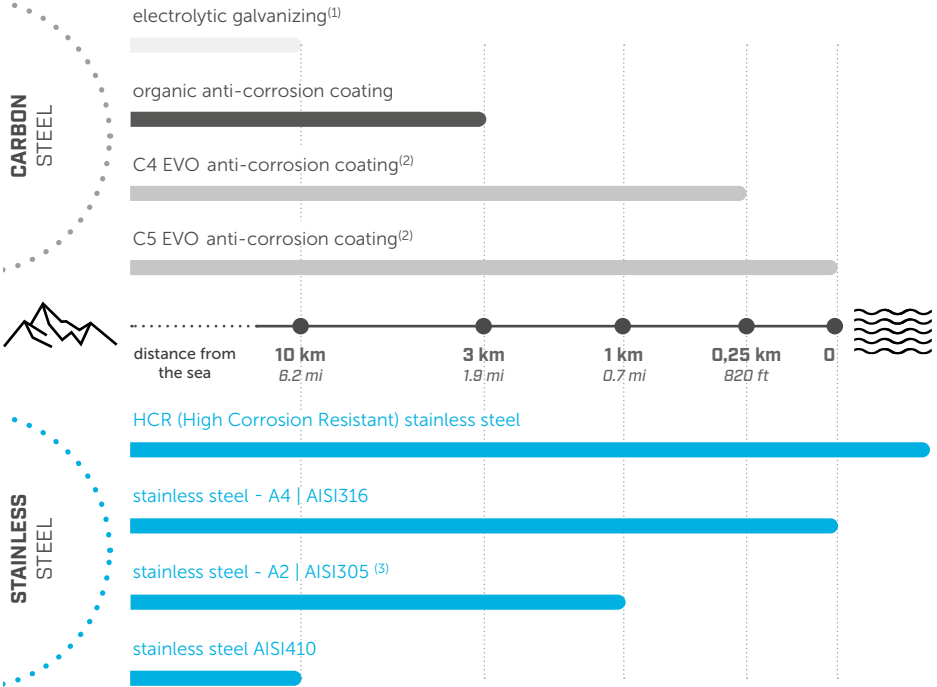

⁽¹⁾ Only for protected outdoor exposure conditions.

⁽²⁾ EN 14592:2022 currently limits the service life of alternative coatings to 15 years.

⁽³⁾ A2 AISI304: considering the metal completely exposed to rain.

C4 EVO is a multilayer coating composed of:

- An external functional layer of epoxy matrix with aluminium flakes of around 15-20 µm, which gives the coating optimum resistance to mechanical and thermal stresses. The aluminium flakes also serve, when required, as sacrificial cathodes for the metal base of the screw.
- A central binding layer for the external functional layer.
- An internal layer of around 4 µm zinc microns which acts as an additional layer of corrosion resistance.

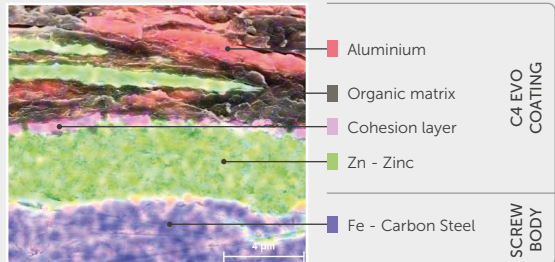

MATERIAL AND COATING SELECTION

T-C CORROSION RESISTANCE

Assessment of the corrosion behaviour of material and coatings depending on the corrosivity class of the environment⁽¹⁾ and the corrosivity class of the timber (according to EN 14592:2022 and EN 1993-1-4:2014).

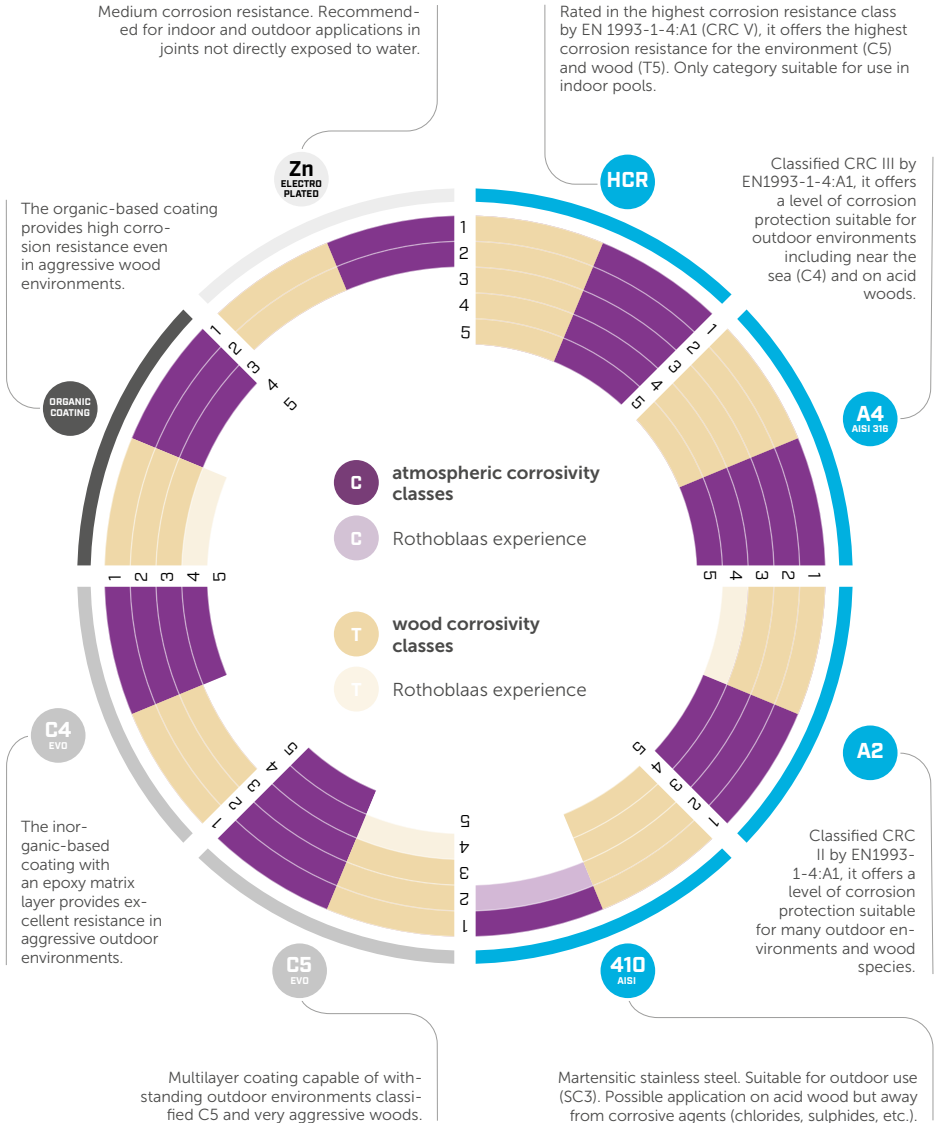

⁽¹⁾ For stainless steel, an equivalent atmospheric corrosivity class was determined considering only the influence of chlorides (salt) and without a cleaning cycle.

COMBINATION WITH PLATES

How to make the right choice?

Screws are often used in combination with metal plates. In such cases, it must be ensured that both components of the connection are sufficiently resistant to the atmospheric environment and the corrosiveness of the timber element.

Start
3 simple steps to find the right solution



selection of metal plate material and coating **2**

LOCK T EVO
OUTDOOR CONCEALED HOOK TIMBER-TO-TIMBER CONNECTOR

LOCK EVO

selection of fastener material and coating based on compatibility with the environment and the plate **3**

HBS PLATE EVO
PAN HEAD SCREW

C4 EVO

1 determination of the various classes (atmospheric, service and wood corrosivity) according to the environment



EXAMPLE:
timber elements directly exposed to the weather in an environment close to the sea

SC3 **C4** **T3**

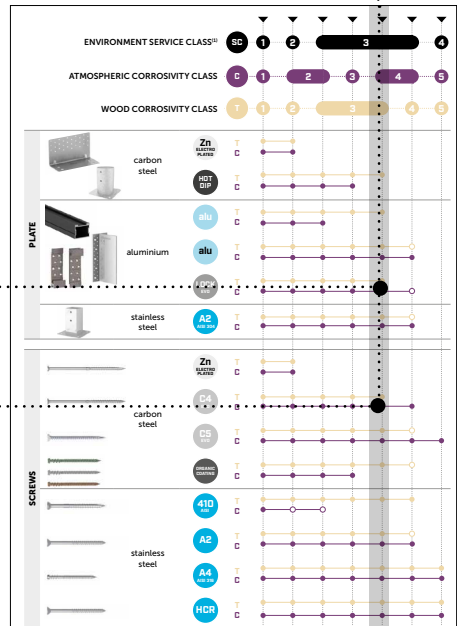

LEGEND:

- use according to regulations
- use according to regulations
- Rothoblaas experience

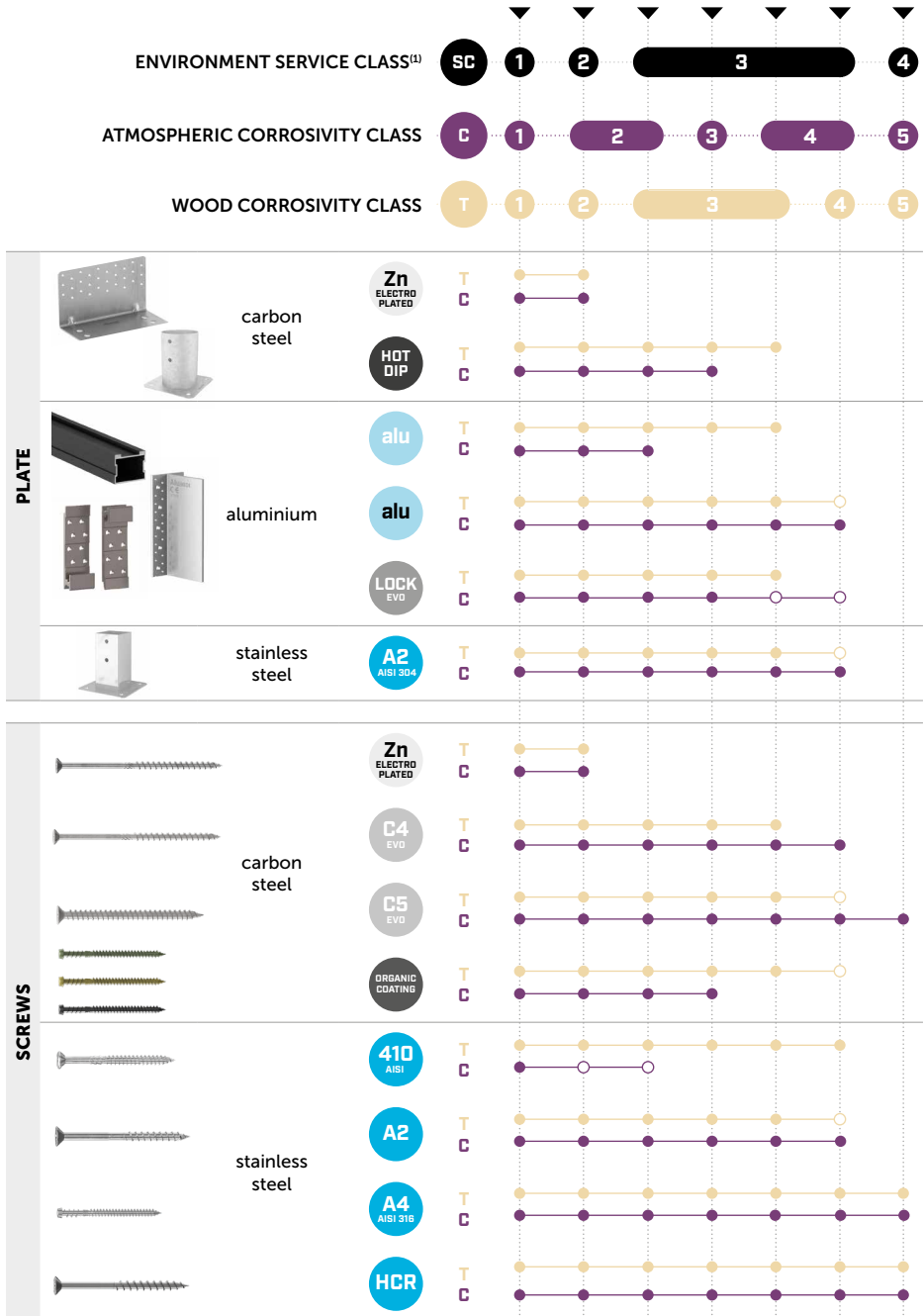

The combination of dissimilar metals in outdoor environments also requires an assessment of the risk of corrosion by galvanic coupling.

⁽¹⁾The correspondence of corrosivity classes C and T with service classes SC is an approximate representation of common cases. There may be special cases that are not included in this table.

GALVANIC COUPLING

The combination of dissimilar metals in outdoor or wet environments requires an assessment of the risk of corrosion by galvanic coupling. For galvanic coupling corrosion to occur, the following 3 conditions must be fulfilled simultaneously:

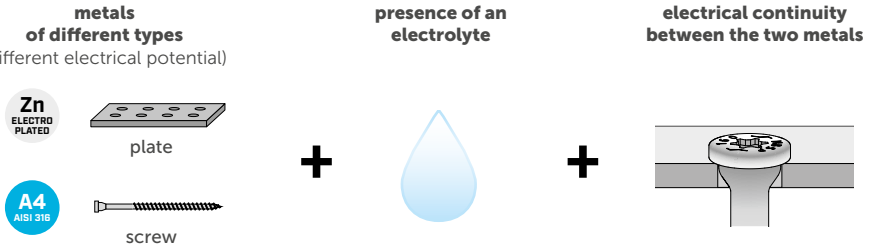

The more dissimilar the metals (greater potential difference), the greater the risk of corrosion. The potential for galvanic corrosion between metals is determined by how far apart they are on the "galvanic series of metals". Approximately, a potential difference greater than 0.4-0.5 V could be considered significant/critical.

Galvanic series of metals: corrosion potential of various metals in salt water

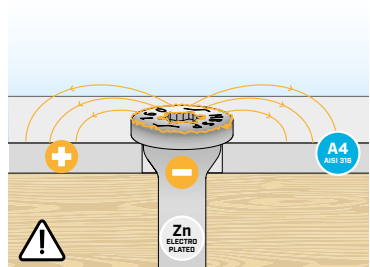
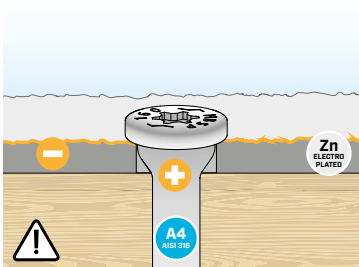
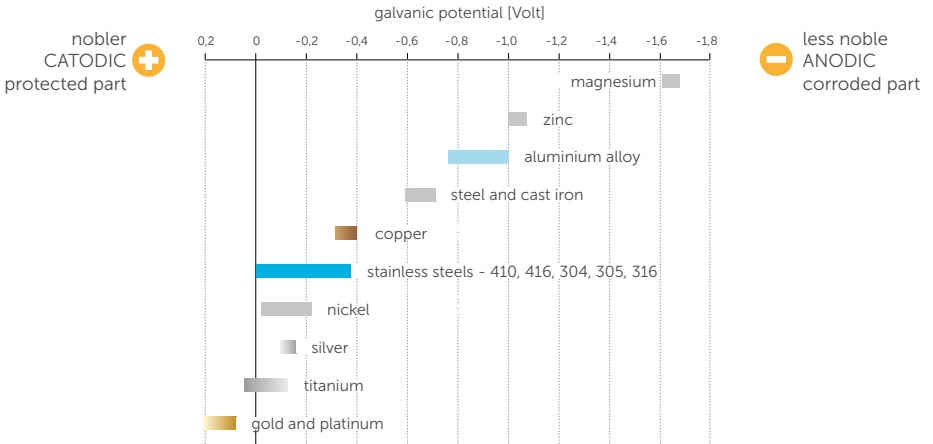

In these cases, the less noble metal (Zn) is dissolved (anodic dissolution), while the more noble part (A4) is not attacked by corrosion (acting as a cathode).

How do you avoid corrosion in connections?

PREVENTION

The following measures can be taken to prevent or minimise the risk of galvanic corrosion:

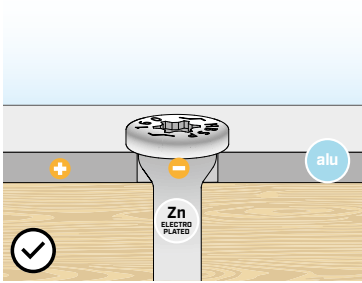

Use similar materials or materials with a small potential difference.

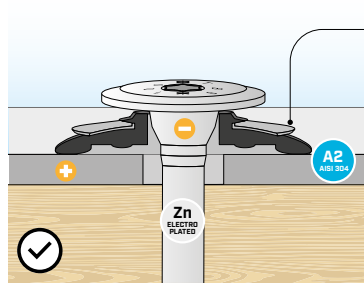

Disconnect the galvanic coupling between the two materials.

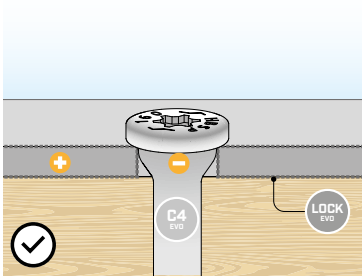

Coat the anode or cathode to prevent electrical connection.

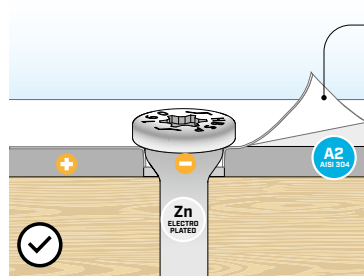

Prevent moisture from coming into contact with both metals.



DISSIMILAR METALS

Sometimes we cannot avoid using dissimilar metals.

In this case, we must ensure that the fasteners (e.g. screws or nails) are of a more noble material than the connection, as is the case with LOCK connectors (aluminium) when used with KKF screws (stainless steel AISI410) in an outdoor context.



TIMBER AND GALVANIC COUPLING

When we talk about timber and galvanic coupling, we must consider the distinction between **free water** and **bonded water**.

Potentially, free water could act as an electrolyte, but the associated risk of galvanic coupling is very low and only occurs if the electrolyte touches both dissimilar materials. Free water does not flow abundantly from the timber cells.

Bound water can't act as an electrolyte because it's bound within the cells of the timber.

Since the equilibrium moisture content of timber is close to 12 % and there is no free water in timber with a moisture content of less than 20 %, **the timber surrounding the connection can protect the connection from galvanic corrosion** by absorbing excess moisture and prevent a build-up of free water.

SHRINKAGE AND SWELLING

The behaviour of timber material



HYGROSCOPIC

Wood is a living, porous and hygroscopic material, which means that by its nature it can acquire or lose moisture depending on the environmental conditions in which it is located.

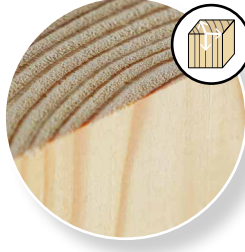

ANISOTROPIC

The mechanical performance and deformations in a timber element are dependent on the direction (longitudinal and radial/tangential).



NOT UNIFORM

There are many different wood species in the world with different and specific characteristics and densities.

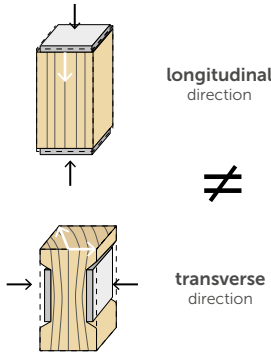
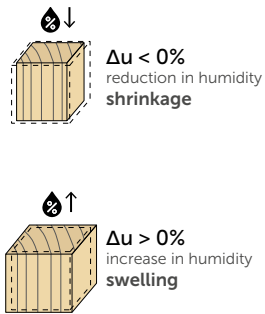

depending on the wood species
different densities

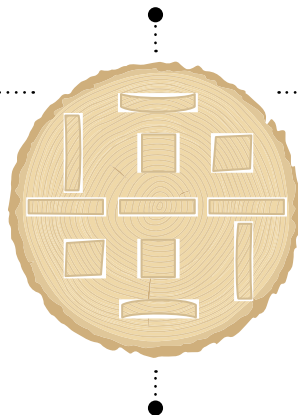

DIFFERENT DIMENSIONAL VARIATIONS

depending on moisture variation, direction relative to the grain and wood species

HYGROSCOPY

RESIDUAL MOISTURE

How moisture influences the behaviour of timber

Wood puts itself in hygroscopic equilibrium with its environment: it releases or absorbs moisture until it finds a balance point.

Based on the climatic conditions of the environment (temperature and relative air humidity), it is possible to determine the corresponding moisture content within the wood.

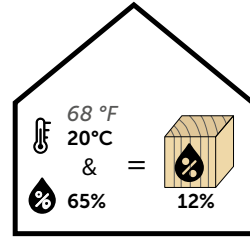
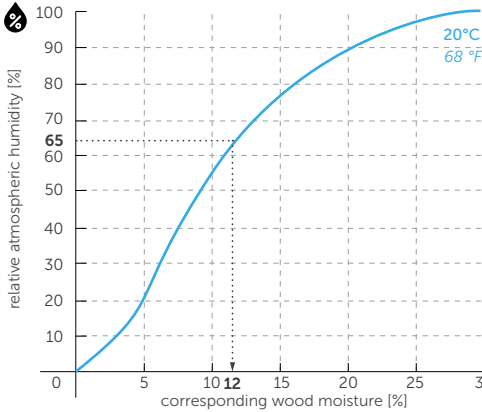

A wooden element placed in an environment with a **relative humidity of 65%** and a **temperature of 20°C (68 °F)** will, in equilibrium, have a corresponding humidity value of **12%**.

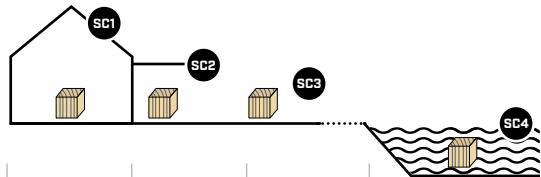

relative atmospheric humidity of the surrounding air (upper limit)	65%	85%	95%	100%
corresponding wood moisture	12%	20%	24%	

As a rule, wood must be supplied with a moisture content as close as possible to that appropriate to the environmental conditions in which it will be in the finished work, so that it is not subject to corresponding moisture variations and consequently to shrinkage or swelling phenomena.

STRENGTH REDUCTION

The presence of moisture in the timber element influences its static performance: for the same stress, an element placed in an environment with high humidity (e.g. SC3) has lower mechanical strength than in SC1. At the design level, appropriate correction coefficients (k_{mod}) must be applied to take this phenomenon into account.

Correction coefficients for load duration and moisture k_{mod} ⁽¹⁾

Solid timber EN 14081-1	Load duration class	SC1	SC2	SC3	SC4
		Permanent	0,60	0,60	0,55
Long	0,70	0,70	0,60	0,55	
Medium	0,80	0,80	0,70	0,65	
Short	0,90	0,90	0,80	0,70	
Instantaneous	1,10	1,10	1,00	0,90	

⁽¹⁾ New generation Eurocodes EN 1995-1-2:2025 (n.a.)

ANISOTROPY AND WOOD SPECIES

*Cellular structure:
how it influences
timber behaviour*

The cellular structure of wood influences its mechanical performance and results in a significant difference in strength and stiffness depending on the direction relative to the grain. Two cases are considered in design: parallel or perpendicular (radial/tangential).

Typical stress-strain curves

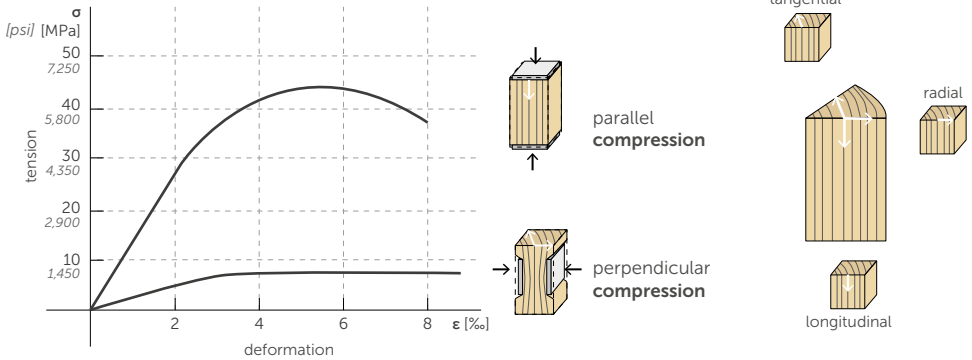

DIMENSIONAL CHANGES DEPENDING ON THE DIRECTION

The phenomena of shrinkage and swelling also differ depending on the direction considered in the timber element. The linear dimensional changes of wood are proportional to the change in moisture content:



$$L_{\text{final}} = L_{\text{initial}} [1 + k_{\text{sh/sw}} (u_{\text{final}} - u_{\text{initial}})]$$

where:

- L_{final} is the dimension associated with the final moisture content
- L_{initial} is the dimension associated with initial moisture content
- $k_{\text{sh/sw}}$ is the shrinkage/swelling coefficient in the direction considered (see table below)
- u_{initial} is the initial moisture content of the wood [%]
- u_{final} is the final moisture content of the wood [%]

Shrinkage/swelling coefficients $k_{\text{sh/sw}}$ ⁽¹⁾

for a 1% change in residual moisture content in direction:

	 longitudinal direction	 radial direction	 tangential direction
conifers, Cornish oak, chestnut, poplar	0,0001	0,0012	0,0024
turkey oak	0,0001	0,0020	0,0040
glued laminated softwood	0,0001	0,0025	0,0025

Hygroscopic dimensional changes (shrinkage and swelling) occur for moisture content below the Fibre Saturation Point (FSP), which conventionally corresponds to a moisture content of 30%. For moisture content above the FPS, there are changes in mass but not in volume.

⁽¹⁾ CNR-DT 206 R1/2018

SWELLING: DIMENSIONAL CHANGES

GLULAM BEAM

$L_{initial}$	initial length	4000 mm	13 ft - 1 1/2 in
$B_{initial}$	initial base	120 mm	4 3/4 in
$H_{initial}$	initial height	200 mm	7 7/8 in
$V_{initial}$	initial volume	0,096 m ³	3,39 ft ³
material	GL24h Glulam ($\rho_k = 385 \text{ kg/m}^3$)		$G = 0,44$

$u_{initial}$	initial moisture	10%
u_{final}	final moisture	20%
Δu	difference in moisture	10%

	parallel	perpendicular
$k_{sh/sw}^{(1)}$	0,0001	0,0025

*Small variations
in moisture, large
deformations*

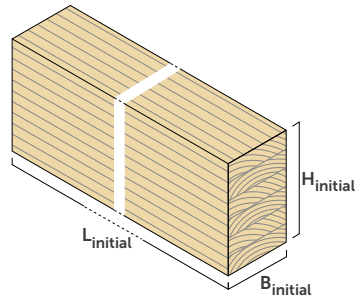

L_{final}	final length	4004 mm	13 ft - 1 11/16 in
B_{final}	final base	123 mm	4 7/8 in
H_{final}	final height	205 mm	8 1/16 in
V_{final}	final volume	0,101 m ³	3,57 ft ³

DIMENSIONAL CHANGES

+4 mm	+3/16 in	+0,1%
+3 mm	+1/8 in	+2,5%
+5 mm	+3/16 in	+2,5%
+0,005 m³	+0,18 ft³	+5,2%

$\Delta u = 10\%$

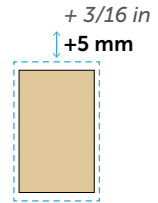

+4 mm
+3/16 in

+3 mm
+1/8 in

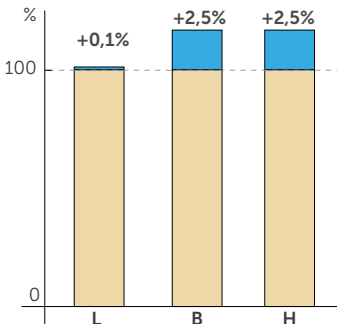

The dimensional variations found, while similar in absolute value, are much more pronounced in the transverse direction than in the longitudinal direction.

Usually, in timber structures, the construction tolerance is in the millimetre range; swelling or shrinkage that is not taken into account and accommodated generates **stress increases** and localised cracking or splitting phenomena.

⁽¹⁾ DIN EN 1995-1-1/NA:2013-08

SWELLING: STRESS INCREMENTS

TIMBER-TO-TIMBER

A change in moisture within a timber element causes additional stress on the connector⁽¹⁾.

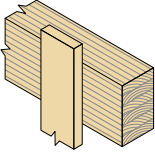

LATERALLY LOADED SCREWS

The connector restricts on the free deformation of the wood: swelling could cause an increase in the embedment stress on the connector axis, which results in an additional shear load.

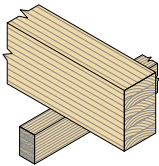
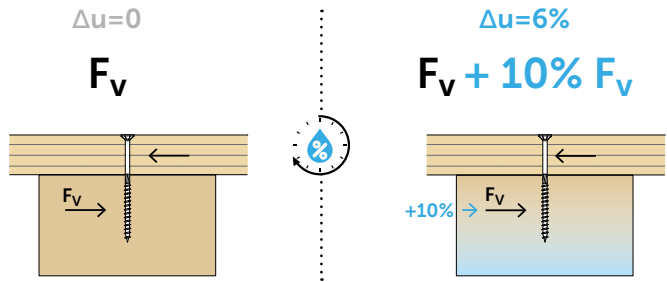

AXIALLY LOADED SCREWS

The impeded swelling results in a concentrated load at the screw head, which tends to penetrate into the timber element.

The connector is subjected to a load even in the absence of stresses acting on the connection.

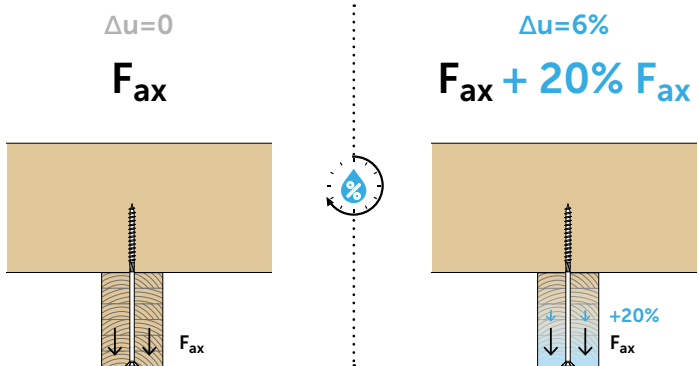

⁽¹⁾ DIN EN 1995-1-1/NA:2013-08 and DIN EN 1995-1-1:2010-12

Moisture variations affect the strength of connections

STEEL-TO-TIMBER

A metal plate creates a rigid confinement of the wood and prevents its deformation induced by changes in moisture content.

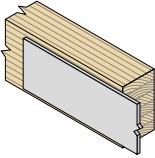

LATERALLY LOADED SCREWS

When used with a metal plate, the connector has less capacity to accommodate material deformations. The connector is subjected to a load even in the absence of stresses acting on the connection.

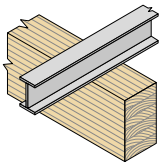
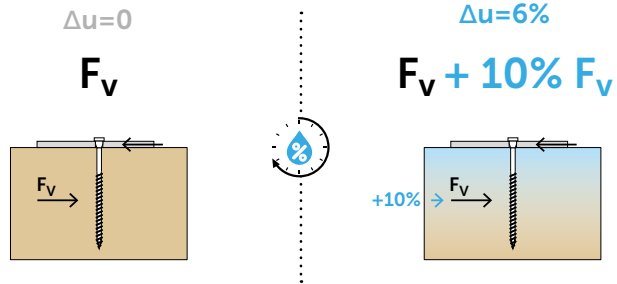

AXIALLY LOADED SCREWS

The connector is significantly stressed in the axial direction if it is positioned in such a way that it cannot allow the movement of the wood.

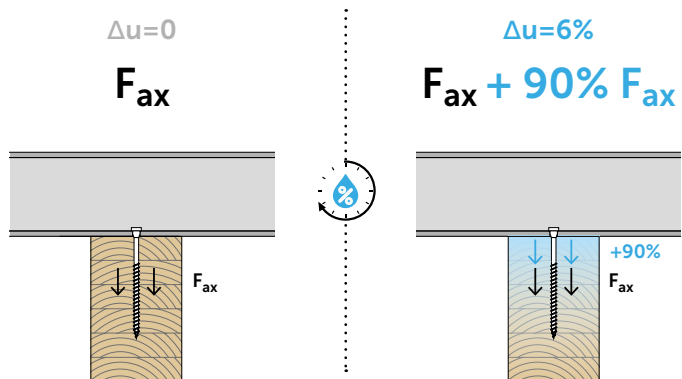

SWELLING: CONFINED ELEMENTS

*Steel-to-timber:
attention to
stresses*

The metal element represents a rigid confinement of the timber: in the presence of a change in moisture, the element is not free to swell.

Prevented swelling generates compressive force on timber.

The timber element retains its initial geometry and size but not its stress state.

When you have a confined element, the connector is subject to a load even in the absence of external loads acting on the connection if there is a change in moisture.

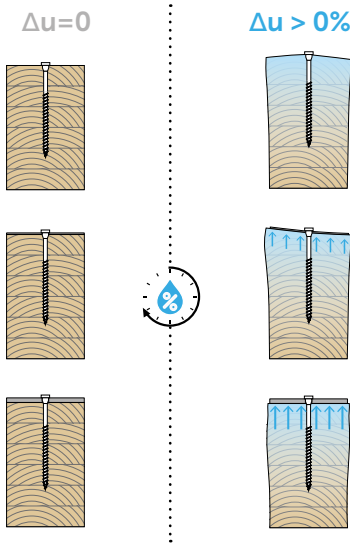

FREE ELEMENT

If the element is not confined, it can deform freely.

The connectors inside will still be subject to additional stress.

THIN PLATE

The constraint is not rigid enough to prevent the timber from swelling; the plate deforms to accommodate the movement but is constrained by the connector.

THICK PLATE

The metal element does not deform; the dimensional change of the timber occurs unevenly and generates significant additional stresses on the connector.

DESIGN BEST PRACTICES

It must be verified that swelling and shrinkage do not compromise the performance of other structural members by generating unintentional stresses that affect strength or deflection.

The design and installation of partially or fully threaded self-tapping screws must take into account the moisture conditions of the timber elements and the fluctuations that may occur during transport, assembly, construction and operation. The design must consider possible additional stresses related to temporary conditions.

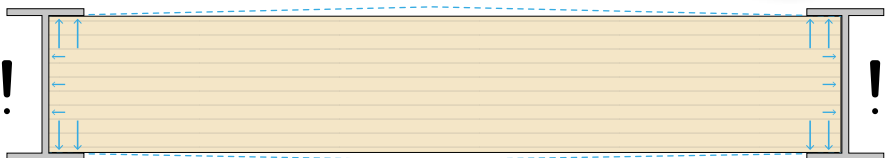

For more information on METAL-TO-TIMBER installation see page 63.

EXPERIMENTAL TESTING

An experimental campaign was carried out in our laboratory to assess the stress increase on connectors as a result of moisture changes in timber.

During the tests, about **20 configurations** were analysed by combining **3 different types** installation conditions in **steel-to-timber connections**.

The specimens were placed in defined environments in which the moisture content of the timber elements could be varied in a controlled manner.

The screws were extracted on a **daily basis** to assess the influence of the different variables involved.

SET-UP

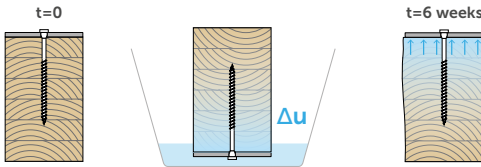

wood:	glulam (softwood)
exposure time:	6 weeks
screws:	HBS PLATE
initial moisture content:	11%
final moisture content:	40%



RESULTS:



FIRE

How different is the behaviour of timber compared to steel?

FIRE BEHAVIOR

Timber structures properly designed ensure high performance also under fire circumstances.



TIMBER

Timber is a combustible material that burns at a predictable rate: when exposed to fire, a portion of the cross section is lost through charring and pyrolysis while the inner, residual section retains its mechanical characteristics (strength and stiffness).

One-dimensional design (effective) charring rate for solid timber and glulam $\beta_0 \approx 0,65 \text{ mm/min}$ ($\beta_{\text{eff}} \approx 1.8 \text{ in/hr}$)

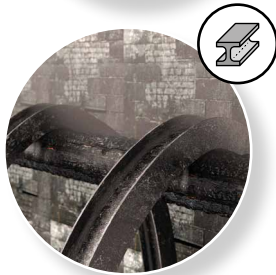

METAL

Metals, primarily steel used in the construction of timber buildings, are noncombustible materials that are highly heat conductive and can cause structural failures during fire events if not detailed and protected correctly. When exposed to fire and high temperatures, the mechanical properties (strength and stiffness) of metal rapidly decrease.

If not considered, it may cause an unintended collapse of the connection.

WHY DOES TIMBER RESIST FIRE?

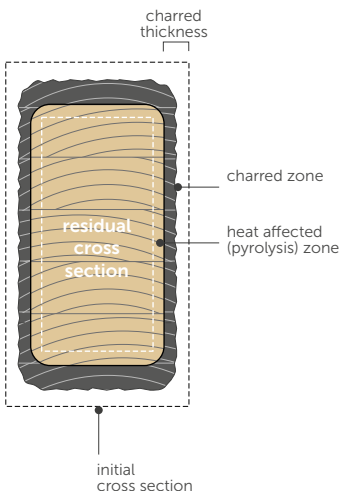

Timber is a combustible material that can be completely destroyed if exposed to external heat sources for long durations and high intensities. However:

- timber is a hygroscopic material containing water, which considerably slows down the penetration of heat into the section, even at very high outside temperatures;
- The charred layer acts as an insulator against heat penetration into the section, as the hot gases produced during pyrolysis slow down the temperature increase in the layer itself.

Looking at the cross-section of a timber element after it has been exposed to fire, three layers can be identified:

- a **charred zone** corresponding to the layer of wood completely affected by the combustion process;
- a **heat affected (pyrolysis) zone** that has not yet been charred but has undergone temperature increases above 100°C (212°F), which is assumed to have zero residual resistance;
- a **residual section** that retains its initial strength and stiffness properties.

RESIDUAL CAPACITY

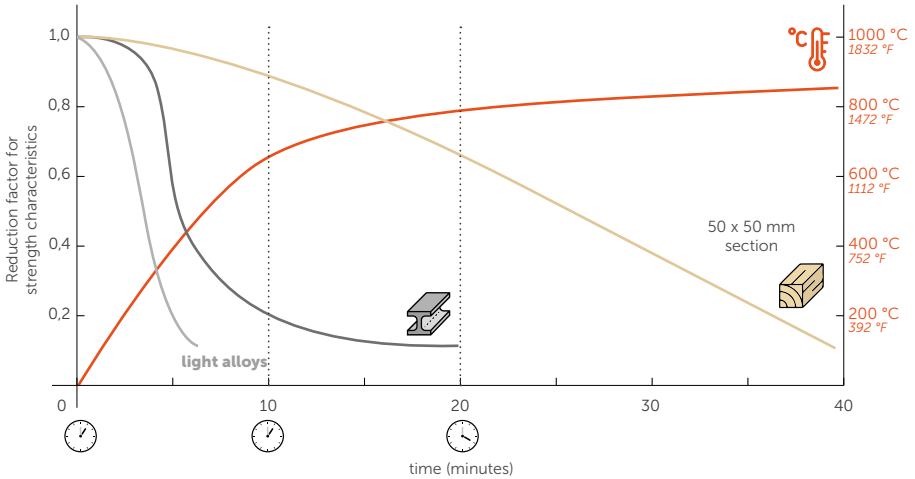

Instance t=0

both materials have 100 % strength

0 min

0 °C
~32 °F



100%

$$R = R_{t_0}$$



100%

$$R = R_{t_0}$$

Instance t=10 min

for steel the strength has been reduced to 20% while for timber it is still 85%

10 min

~600 °C
~1112 °F



20%

$$R = 0,20 R_{t_0}$$



85%

$$R = 0,85 R_{t_0}$$

Instance t=20 min

steel has collapsed and no longer has any strength while timber has 65% strength left

20 min

~800 °C
~1472 °F



0%

$$R = 0$$



65%

$$R = 0,65 R_{t_0}$$

STEEL and LIGHT ALLOYS:

development of the strength characteristics of metal elements subjected to normalised fire (irrespective of section size).

TIMBER: development of the strength characteristics of timber elements subjected to normalised fire (the curve varies with the size of the section).

ISO 834 standard fire curve (ASTM E119 similar)

METAL CONNECTORS

What influences the fire behaviour of a connector?

Steel has a much higher thermal conductivity than timber: if exposed to the same heat source, it will heat up much faster than timber and will also transmit the heat to the inside of the section, generating an internal charred layer.

DIAMETER

The larger the diameter of the connector, the more heat it will transmit to the inside of the timber

Ø20 (0.79 in) bolt exposed to a heat source

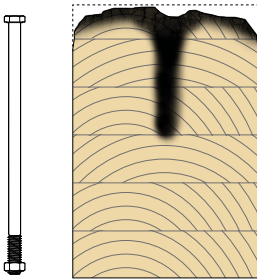

Ø12 (0.48 in) screw with head exposed to a heat source

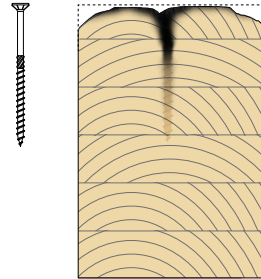

LENGTH



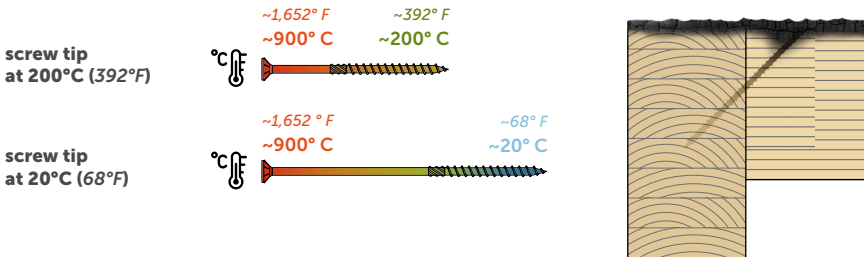



The length, as well as the diameter, material and type of screw head also affect heat transmission. The longer the screw, the lower the temperatures because the tip of the connector is away from the heat source and is in a cooler area of timber.

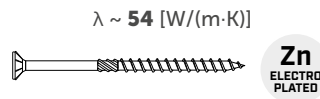
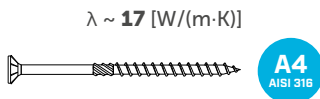

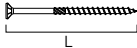
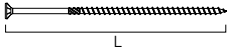
MATERIAL

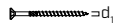
With the same geometry, stainless steel performs better than carbon steel. Having a lower conductivity coefficient, temperatures along the length of a stainless steel screw are lower and the charred zone around it is smaller.

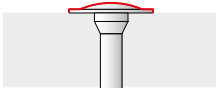

parameter	influence on fire behaviour	worst behaviour	best behaviour
LENGTH	significant		
DIAMETER	medium		
MATERIAL	medium	 Zn ELECTRO PLATED	 A4 A19-316
TYPE OF HEAD	low		

THE IMPORTANCE OF PROTECTION

Covering the screw head or protecting the metal from direct exposure to fire brings significant benefits in terms of heat propagation and charring depth.

In fact, the charring depth can be reduced by varying the penetration depth of the head into the timber: greater the penetration depth into the wood, less will be the charring depth. By then covering the head with a timber plug, charring along the length of the screw will be zero.

variables: s_i : thickness of head penetration into timber
 s_c : charring thickness

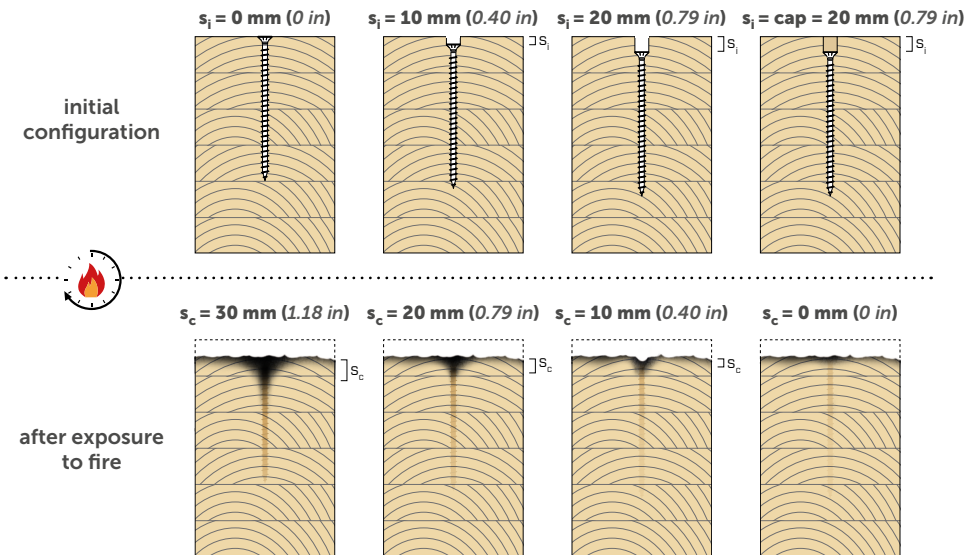

Rif. N. Werther, M. Gräfe, V. Hofmann, S. Winter „Untersuchungen zum Brandverhalten von querkraft- beanspruchten Verbindungen bei Holzbaukonstruktionen, Neuentwicklung und Optimierung von Verbindungssystemen und allgemeinen Konstruktionsregeln, 2015“

FIRE RESISTANCE

Fire resistance indicates the ability of a building element to maintain structural stability during a fire condition for a given period of time, while retaining the ability to compartmentalise smoke and hot gases generated by combustion. The primary purpose of fire resistance is to ensure the load-bearing capacity of the structure under fire conditions. The characteristics that must be maintained during the action of fire are indicated by three letters:

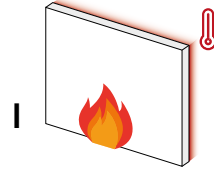
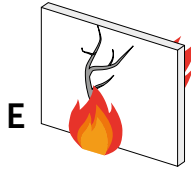
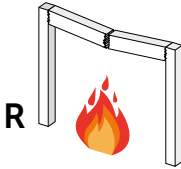

- R** **load bearing** ability of the building element to maintain mechanical resistance under the action of fire
- E** **tightness** ability of the assembly to resist the passage of flames, vapour and hot gasses to other areas of the structure
- I** **thermal insulation** ability of the assembly to limit heat transmission to other areas of the structure

The fire resistance abbreviation is followed by numbers indicating the minutes of stability in case of fire.

 **REI120** the **mechanical strength, smoke tightness** and **thermal insulation** of the element are maintained for 120 minutes (2h) after fire outbreak

 **R60** the **mechanical strength** of the element is maintained for 60 minutes after the fire outbreak

Structural frame elements such as columns and beams are only required to maintain load-bearing capacity (R); floors and walls separating building compartments require, all three characteristics (REI).

FULL-SCALE TESTING

In cooperation with RISE - Research Institutes of Sweden, we carried out full-scale tests to determine the EI value of some of the most common joints in timber construction.



RESEARCH PROJECTS

Our next research projects will focus on studying the fire behaviour of the most common nodes in the world of timber construction. Our aim is to study them from every point of view, considering both static and sealing and thermal insulation aspects, in order to understand how the joint response changes during a fire in relation to the elements present.

THE BEST DEFENCE? IT'S PASSIVE!



IT'S NOT TACTICS, IT'S PREVENTION.

Play in advance and handle fire problems with passive protection solutions: design your building by incorporating Rothoblaas tapes, sealants and membranes.



Ask your trusted agent for information or download the product catalogue on our website www.rothoblaas.com

FIRE PROTECTION

We protect timber structures

UNPROTECTED JOINTS⁽¹⁾

TIMBER-TO-TIMBER

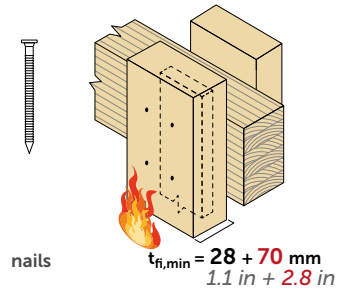
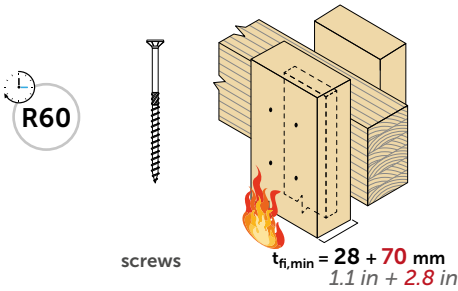
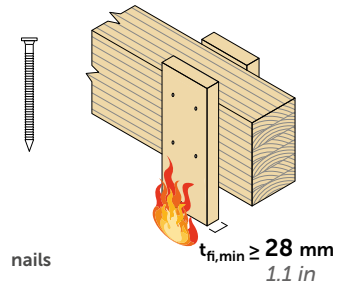
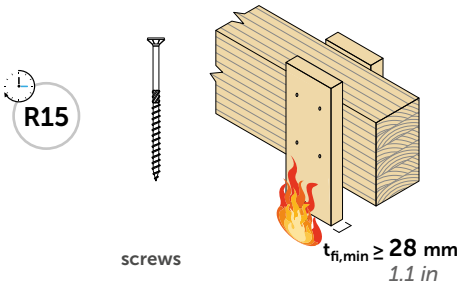

For connections with screws or nails, the fire resistance (R_{td}) can be increased by up to 60 minutes by increasing the size of the timber elements.

STEEL-TO-TIMBER

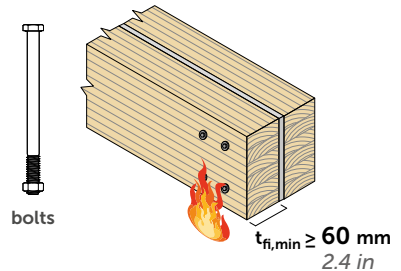
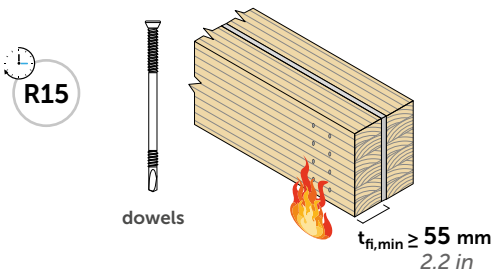

Fire resistance up to 120 minutes can be implemented by increasing the size of the timber elements (t_f) and the edge distances of the metal elements.

For STEEL-TO-TIMBER joints with exposed plate: the rules valid for steel structures apply (EN 1993-1-2).

⁽¹⁾ New generation Eurocodes EN 1995-1-2:2025 (n.a.)

PROTECTED JOINTS

Fire resistance can be achieved by designing **partial or total fire protection systems**. These protection systems can be timber dowels or plugs, timber panels or gypsum board (type A, H or F).

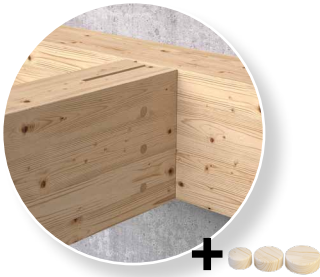

PARTIAL

The partial system selected only protects the connection for part of the required fire resistance time (e.g. 60 minutes resistance required, protection materials will resist fire for 45 minutes, the other 15 minutes must be ensured by the unprotected connection).

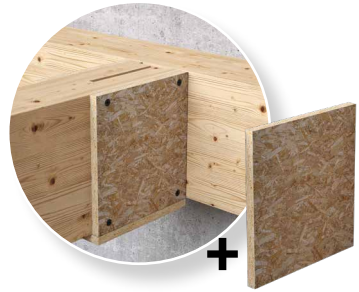

TOTAL

The total system protects the connection for the total fire resistance time required (e.g. 60 minutes protection required, protection materials will resist fire for 60 minutes).

CALCULATION EXAMPLE TIMBER CAP THICKNESS - PARTIAL PROTECTION

[chap. 6.2.1.2 EN 1995-1-2:2025]

Panel thickness ① and dowel depth ② must be calculated according to the desired fire resistance.

$$a_{fi} = \beta_n \cdot 1,5 \cdot (t_{req} - R_{td})$$

where:

a_{fi} = panel/anchor thickness

R_{td} = unprotected connector fire resistance

t_{req} = desired fire resistance

β_n = 0,8 for solid timber, 0,7 in all other cases

Dowel protection with **R60** timber plugs:

$$a_{fi} = 0,7 \cdot 1,5 \cdot (60 - 20) = 42 \text{ mm} \\ 1.65 \text{ in}$$

Note: The penetration depth into the timber of protective board fasteners must be $\geq 6 \cdot d$ ($\geq 10 \cdot d$ in the case of Type F plasterboard).

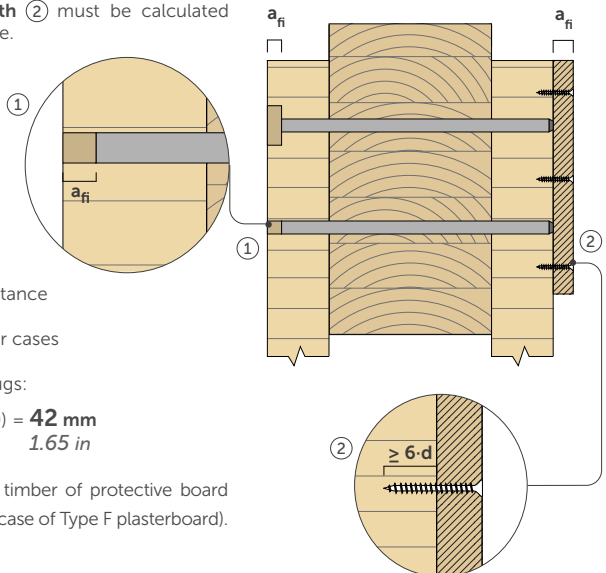

LOADS IN CASE OF FIRE

During an extraordinary event such as a fire, the loads acting on structural elements are considered to be lower than the loads used for the design of structural elements at ultimate limit states (which are increased through coefficients)⁽¹⁾.

EXAMPLE

The snow on a roof during a fire tends to melt and therefore the weight on the structure is less; similarly, during a fire, people leave the premises, via the escape routes, decreasing the accidental category live load acting on the structural elements.

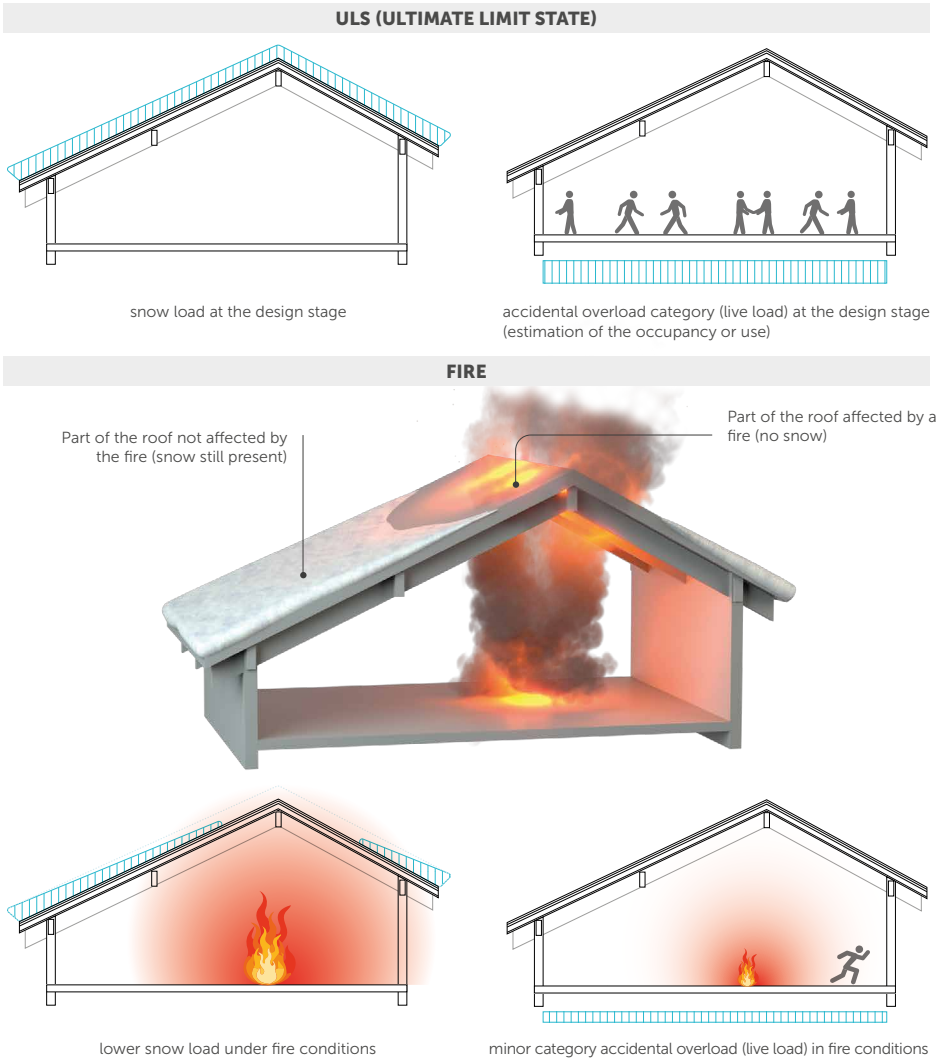

⁽¹⁾In fire design, this difference is accounted for by using (statistically determined) smaller load combination coefficients than for SLU design.

AXIALLY LOADED SCREWS

STRENGTH REDUCTION COEFFICIENT

Since they are subject to a lower load than the load used to design the connections under normal conditions, it is acceptable that the strength of the connection under fire conditions is also lower:

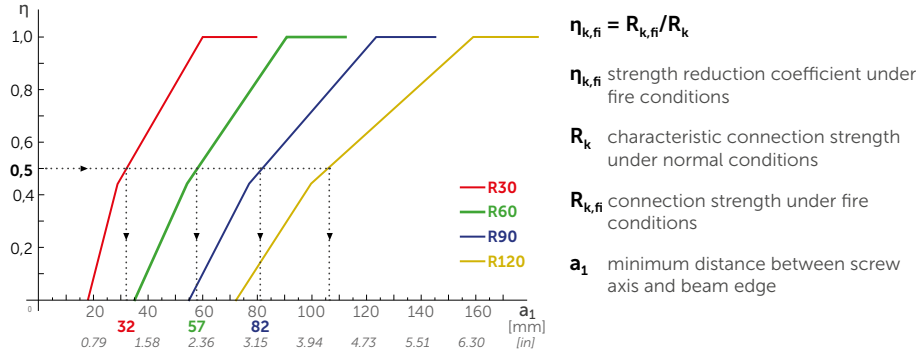

Determination of a_1 from the chosen coefficient η and the desired fire resistance.

For $\eta_{k,fi} = 0,5$

R30
 $a_1 = 32 \text{ mm}$
 1.26 in

R60
 $a_1 = 57 \text{ mm}$
 2.25 in

R90
 $a_1 = 82 \text{ mm}$
 3.23 in

DETERMINATION OF THE SECTION UNDER FIRE CONDITIONS⁽¹⁾

After determining a_1 , the minimum section under fire conditions can be calculated.

$$a_1 = a_{2,CG}$$

$$a_3 \geq a_1$$

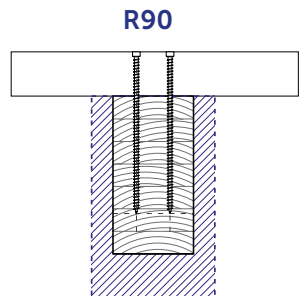
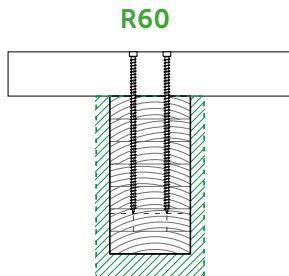
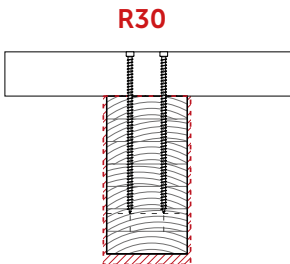
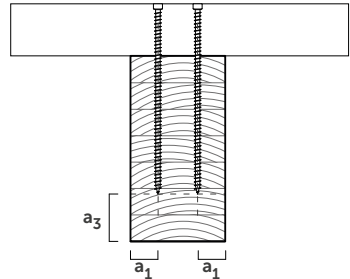

⁽¹⁾ New generation Eurocodes EN 1995-1-2:2025 (n.a.)

CALCULATION EXAMPLE

PROJECT DATA

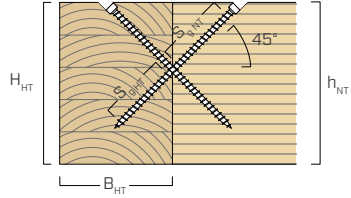
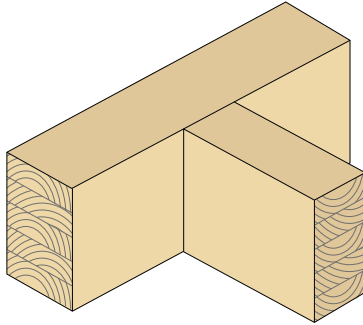

MAIN BEAM

B_{HT}	main beam width	126 mm	4 15/16 in
h_{HT}	main beam height	245 mm	9 5/8 in
GL24h Glulam ($\rho_k = 385 \text{ kg/m}^3$)		$G = 0,44$	

SECONDARY BEAM

b_{NT}	secondary beam width	105 mm	4 1/8 in
h_{NT}	secondary beam height	245 mm	9 5/8 in
GL24h Glulam ($\rho_k = 385 \text{ kg/m}^3$)		$G = 0,44$	

Angle in vertical plane $\alpha=0^\circ$
 Angle in horizontal plane $\beta=0^\circ$

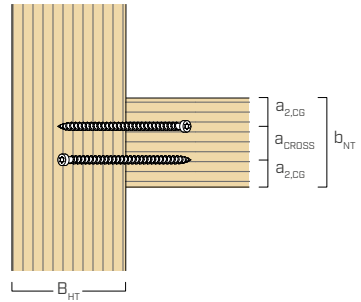

FULLY THREADED SCREW WITH CYLINDRICAL HEAD

L	screw length	300 mm	11 3/4 in
b	thread length	290 mm	11 7/16 in
d_t	nominal diameter	11 mm	0.44 in

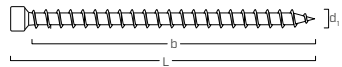

VERIFICATION

Threaded length on head side: $S_{g,HT} = 135 \text{ mm}$ (5 5/16 in);
 Threaded length on tip side: $S_{g,NT} = 135 \text{ mm}$ (5 5/16 in);

STRENGTH REDUCTION COEFFICIENT SELECTION

$\eta_{k,Fi}$ selected equal to **0,5**

CHARACTERISTIC CONNECTOR STRENGTH UNDER STANDARD CONDITIONS:

$F_{V,RK} = 26,52 \text{ kN}$

$R_v = 1,194 \text{ lbf}$
 allowable connector strength under standard conditions

CHARACTERISTIC CONNECTOR STRENGTH UNDER FIRE CONDITIONS:

$F_{V,RK,Fi} = \eta_{k,fi} \cdot F_{V,RK} = 0,5 \cdot 26,52 \text{ kN} = 13,26 \text{ kN}$

$R_{v,fi} = \eta_{v,fi} \cdot R_v = 0,5 \cdot 1,194 \text{ lbf} = 597 \text{ lbf}$
 allowable connector strength under fire conditions

"COLD" GEOMETRY R0

b_{NT}	secondary beam width	105 mm	4 1/8 in
h_{NT}	secondary beam height	245 mm	9 5/8 in
a_{CROSS}		17 mm	11/16 in
$a_{2,CG}$		44 mm	1 3/4 in
a_3		33 mm	1 5/16 in

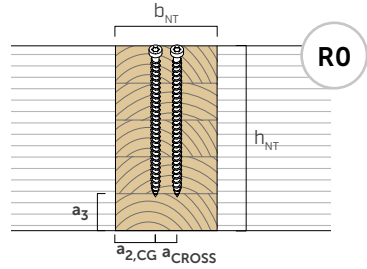

R30 FIRE RESISTANCE

b_{NT}	secondary beam width	+0 mm	105 mm
		0 in	4 1/8 in
h_{NT}	secondary beam height	+11 mm	256 mm
		+7/16 in	10 1/16 in
a_{CROSS}		17 mm	11/16 in
$a_{2,CG} = a_1$		44 mm	1 3/4 in
$a_3 \geq a_1$		44 mm	1 3/4 in

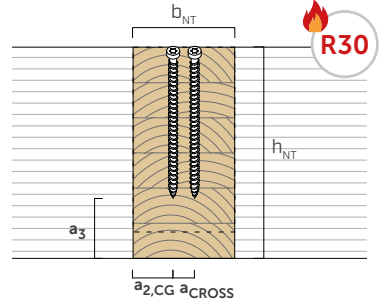

R60 FIRE RESISTANCE

b_{NT}	secondary beam width	+26 mm	131 mm
		+1 in	5 3/16 in
h_{NT}	secondary beam height	+24 mm	269 mm
		+15/16 in	10 9/16 in
a_{CROSS}		17 mm	11/16 in
$a_{2,CG} = a_1$		57 mm	2 1/4 in
$a_3 \geq a_1$		57 mm	2 1/4 in

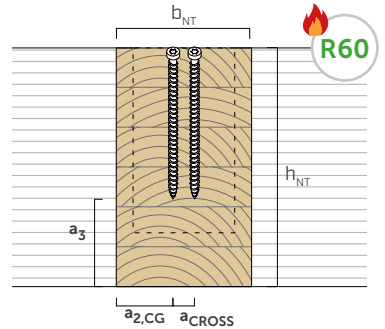

R90 FIRE RESISTANCE

b_{NT}	secondary beam width	+76 mm	181 mm
		+3 in	7 1/8 in
h_{NT}	secondary beam height	+49 mm	294 mm
		+1 15/16 in	11 9/16 in
a_{CROSS}		17 mm	11/16 in
$a_{2,CG} = a_1$		82 mm	3 1/4 in
$a_3 \geq a_1$		82 mm	3 1/4 in

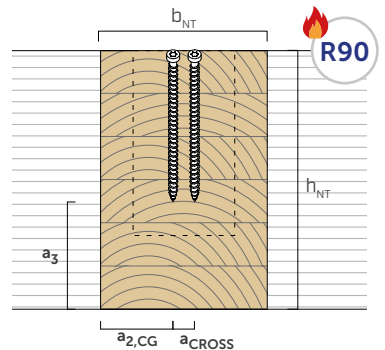

MINIMUM DISTANCES IN CASE OF FIRE

CROSSED SCREWS INSTALLED AT AN ANGLE α TO THE GRAIN⁽¹⁾

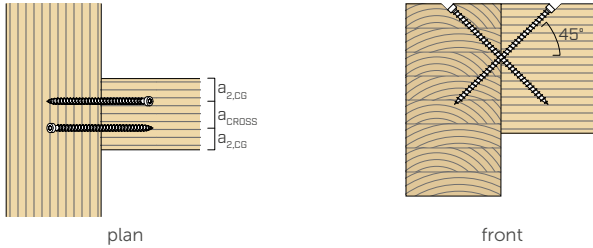

		SCREWS INSERTED WITH AND WITHOUT PRE-DRILLING HOLE						
d_1		7	0.28	9	0.36	11	0.44	
		[mm]	[inch]	[mm]	[inch]	[mm]	[inch]	
R0	$a_{2,CG}$	4-d	21 ⁽²⁾	13/16"	36	1 7/16"	44	1 3/4"
	a_{CROSS}	1.5-d	11	7/16"	14	9/16"	17	11/16"
R30	$a_{2,CG}$	-	32	1 1/4"	36	1 7/16"	44	1 3/4"
	a_{CROSS}	1.5-d	11	7/16"	14	9/16"	17	11/16"
R60	$a_{2,CG}$	-	57	2 1/4"	57	2 1/4"	57	2 1/4"
	a_{CROSS}	1.5-d	11	7/16"	14	9/16"	17	11/16"
R90	$a_{2,CG}$	-	82	3 1/4"	82	3 1/4"	82	3 1/4"
	a_{CROSS}	1.5-d	11	7/16"	14	7/16"	17	11/16"

SCREWS IN TENSION INSTALLED AT AN ANGLE α TO THE GRAIN⁽¹⁾

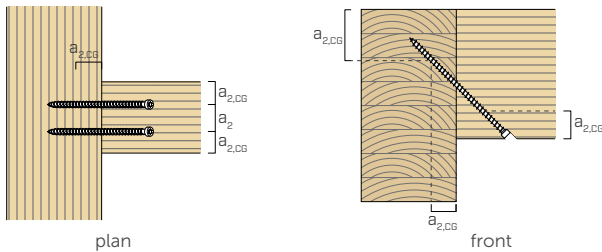

		SCREWS INSERTED WITH AND WITHOUT PRE-DRILLING HOLE						
d_1		7	0.28	9	0.36	11	0.44	
		[mm]	[inch]	[mm]	[inch]	[mm]	[inch]	
R0	$a_{2,CG}$	4-d	21 ⁽²⁾	13/16"	36	1 7/16"	44	1 3/4"
	a_2	5-d	35	1 3/8"	45	1 3/4"	55	2 3/16"
R30	$a_{2,CG}$	-	32	1 1/4"	36	1 7/16"	44	1 3/4"
	a_2	5-d	35	1 3/8"	45	1 3/4"	55	2 3/16"
R60	$a_{2,CG}$	-	57	2 1/4"	57	2 1/4"	57	2 1/4"
	a_2	5-d	35	1 3/8"	45	1 3/4"	55	2 3/16"
R90	$a_{2,CG}$	-	82	3 1/4"	82	3 1/4"	82	3 1/4"
	a_2	5-d	35	1 3/8"	45	1 3/4"	55	2 3/16"

Values calculated using $\eta_{k,fi} = 0,5$ | $a_{2,CG} = a_1$ according to EN 1995-1-2:2025

⁽¹⁾ New generation Eurocodes EN 1995-1-2:2025 (n.a.)

⁽²⁾ For main beam-secondary beam joints with VGZ screws $d = 7$ mm (0.28 in) inclined or crossed, inserted at an angle of 45° to the secondary beam head, with a minimum secondary beam height of 18-d, the minimum distance $a_{2,CG}$ can be taken equal to $3 \cdot d_1$



ROTHOBLAAS THE PRACTICAL SCHOOL, USEFUL GUIDEBOOKS



Do you want to build in timber?
We can give you the most up-to-date training,
the smartest guides, the right products.

www.rothoblaas.com



rothoblaas

Solutions for Building Technology

APPLICATIONS AND SCREWS

PARTIALLY THREADED SCREWS

STRENGTH

Concentration of stresses at localised areas in the direction of the load. Resistance is dependent on the bearing stress on the hole in the timber and the bending of the screw.

SCREWS FOR SHEAR LOADS

RESISTANCE PROPORTIONAL TO THE DIAMETER

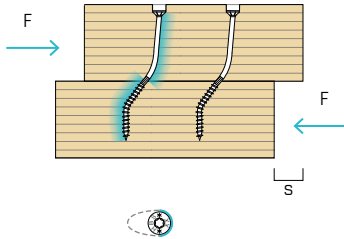

STIFFNESS

- high slip
- low stiffness
- high ductility



FULLY THREADED SCREWS

STRENGTH

Stress distributed along the entire surface of the thread. High resistance associated with the surrounding timber engaged by tangential stresses.

CONNECTORS STRESSED AXIALLY

RESISTANCE PROPORTIONAL TO THE THREADED LENGTH

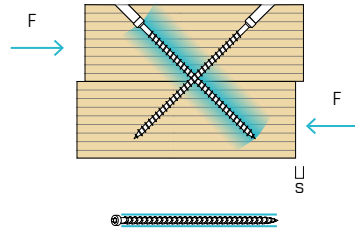

STIFFNESS

- limited slip
- high stiffness
- reduced ductility

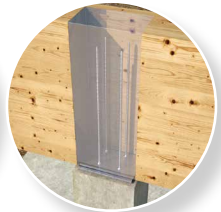

COMPARISON OF SCREWS

BEAM-TO-BEAM CONNECTION

Connection of two glulam beams (GL24h characteristic density = 385 kg/m³, Specific Gravity = 0,42) of height H = 200 mm (7 3/4 in) loaded parallel to the grain. Design according to EN 1995-1-1:2004/A2:2014.

SOLUTION A

TBS partially thread screw
 Ø8 x 300 mm (0.32 in x 11 3/4 in)
4 screws

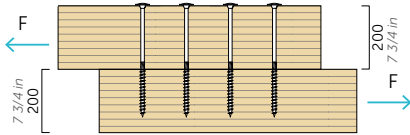

SOLUTION B

VGZ fully threaded screw
 Ø9 x 400 mm (0.36 in x 15 3/4 in)
1 screw

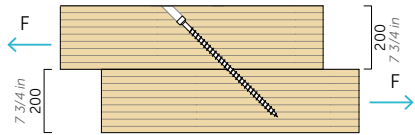

STRENGTH

$$R_{v,k} = 14,4 \text{ kN}$$

$$Z = 980 \text{ lbf (ASD)}$$

≈

$$R_{v,k} = 14,9 \text{ kN}$$

$$Z = 800 \text{ lbf (ASD)}$$

4 partially threaded screws are required to equal the sliding resistance of 1 fully threaded screw inclined at 45°.

STIFFNESS

$$K_{ser} = 6,1 \text{ kN/mm}$$

$$34.8 \text{ kip/in}$$

<<

$$K_{ser} = 29,4 \text{ kN/mm}$$

$$167.9 \text{ kip/in}$$

A joint constructed with fully threaded screws is capable of providing greater stiffness: under the same stress, there will be less deformation than with partially threaded screws.

CONNECTION WITH CROSSED SCREWS

The vertical shear force F is distributed over the screws installed at 45°, stressing them axially.

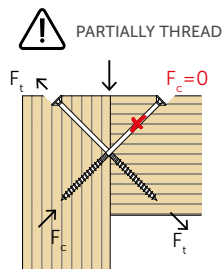
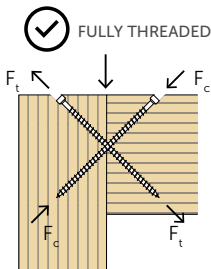
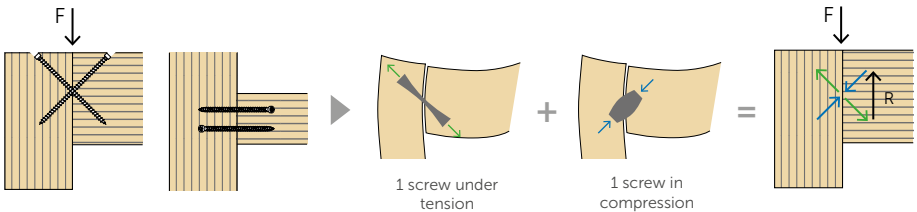

The threaded portion provides excellent performance in both tensile and compressive forces and enables a high overall strength to be achieved.

The screw head does not resist compression forces (it pulls out of the timber) and offers limited capacity for tension forces (pull-through < thread withdrawal).

PARTIALLY THREADED SCREWS

*Shear-stressed screws:
resistance proportional
to diameter*

TIMBER-TO-TIMBER CONNECTION

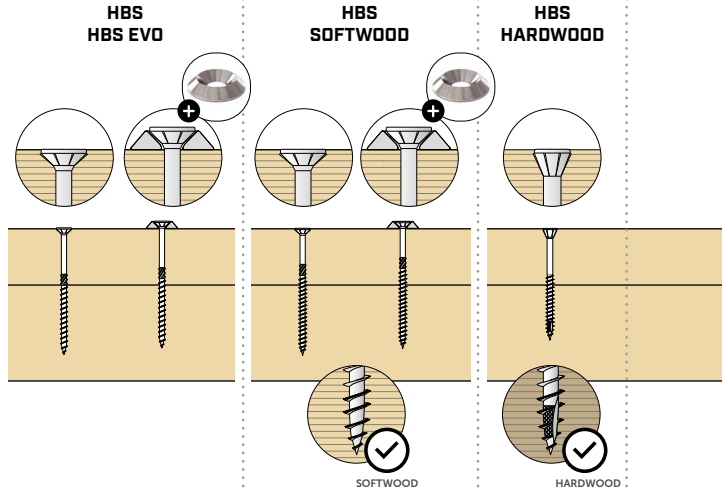

METAL-TO-TIMBER CONNECTION

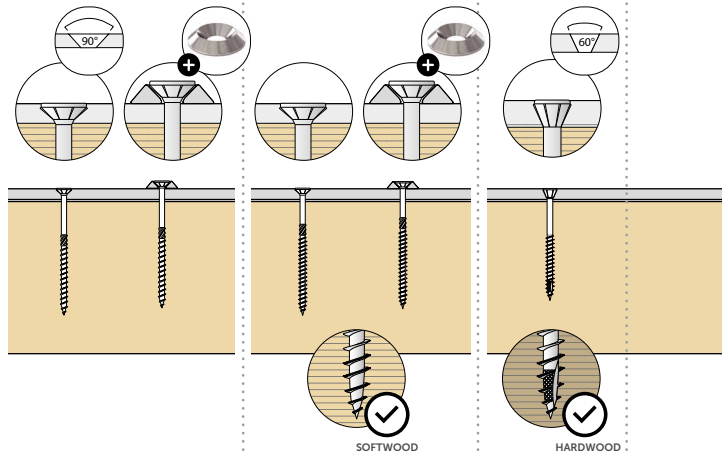

approximate oven dry specific gravity, G	average density lb/ft ³	average density	characteristic density kg/m ³
0.35	22.5	360	300
0.46	30.0	480	400
0.56	37.5	600	500
0.68	45.0	720	600
0.80	52.5	840	700
0.92	60.0	960	800
1.03	67.4	1080	900
1.15	74.9	1200	1000

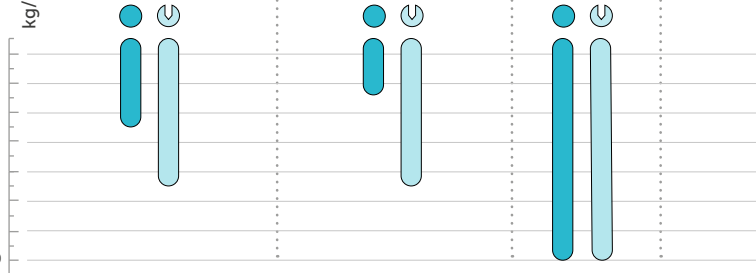

LEGEND:

- installation without pre-drilled hole
- ⊂ installation with pre-drilled hole

- ⊂ use not recommended but possible with specific precautions

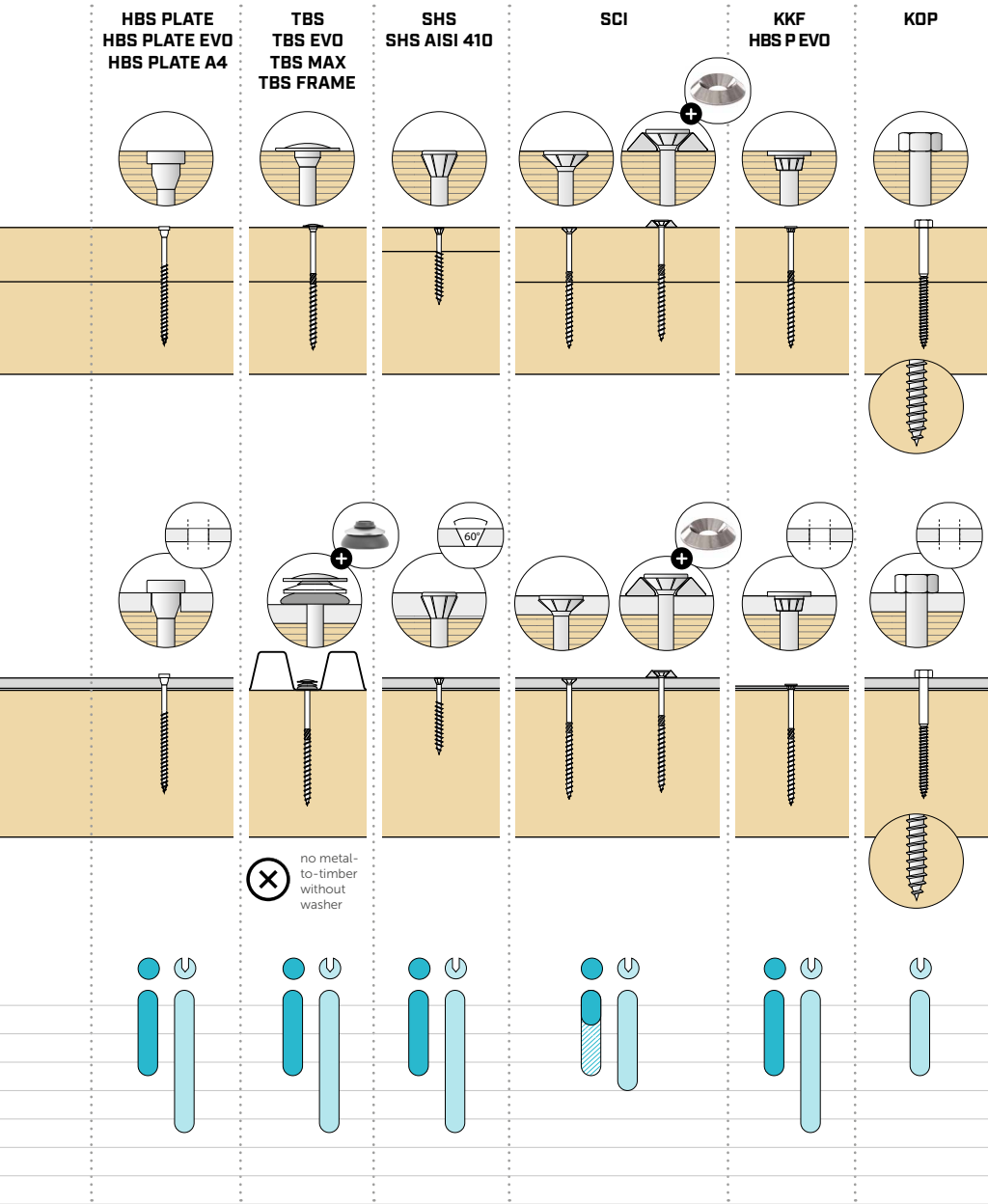

Structural screws are considered to be ($\varnothing \geq 6\text{mm}-0.24\text{ in}$)

FULLY THREADED SCREWS

*Connectors stressed axially:
resistance proportional
to the length*

TIMBER-TO-TIMBER CONNECTION

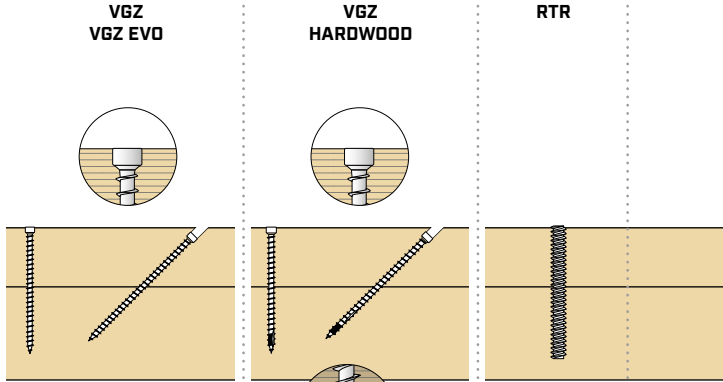

metal-to-timber application
not recommended

metal-to-timber application
not recommended

metal-to-timber application
not recommended

METAL-TO-TIMBER CONNECTION

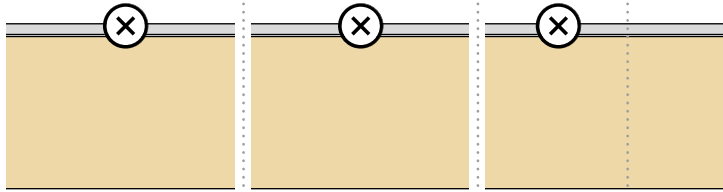

approximate oven dry specific gravity, G	average density lb/ft ³	average density	characteristic density kg/m ³
0.35	22.5	360	300
0.46	30.0	480	400
0.56	37.5	600	500
0.68	45.0	720	600
0.80	52.5	840	700
0.92	60.0	960	800
1.03	67.4	1080	900
1.15	74.9	1200	1000

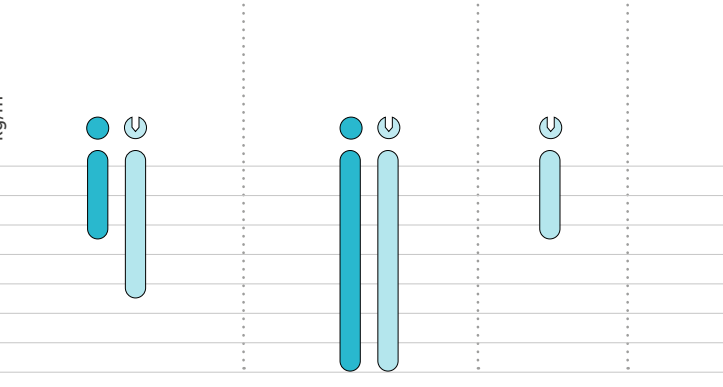

LEGEND:

- installation without pre-drilled hole
- ◐ installation with pre-drilled hole

- ⊗ use not recommended but possible with specific precautions

VGS
VGS EVO
VGS A4

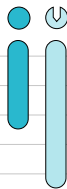
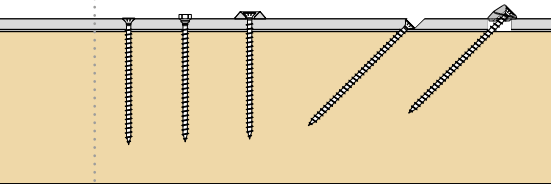
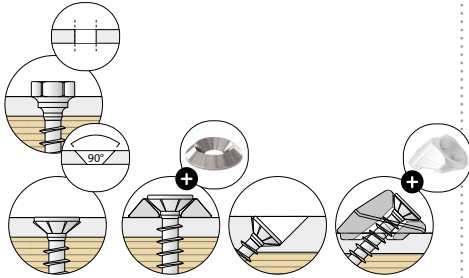
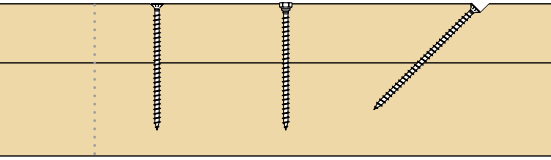
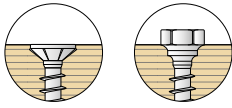

LBS
LBS EVO

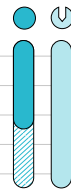
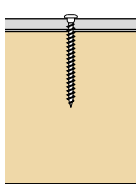
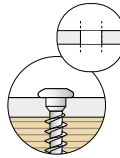
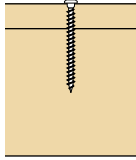
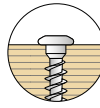

LBS
HARDWOOD
LBS
HARDWOOD EVO

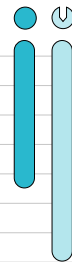
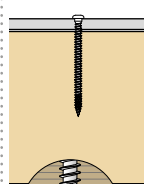
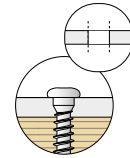
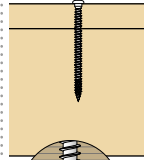
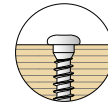

HTS

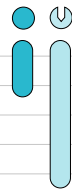
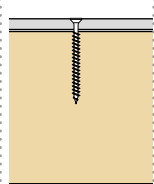
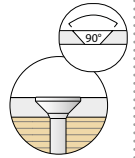
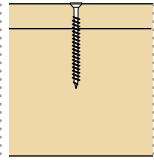
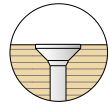

Structural screws are considered to be ($\varnothing \geq 5 \text{ mm} - 0.20 \text{ in}$)

OUTDOOR SCREWS

Appropriate solutions for numerous material and density combinations

TIMBER-TO-TIMBER CONNECTION

KKT
A4 | AISI316

SCI
A4 | AISI316

KKZ
A2 | AISI304

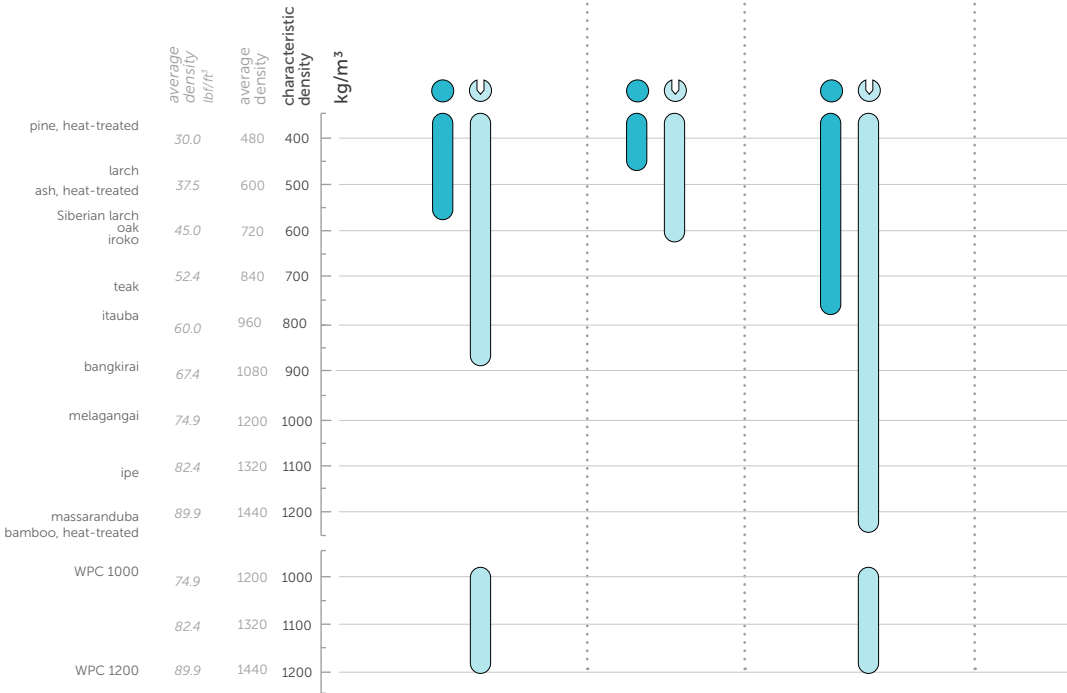
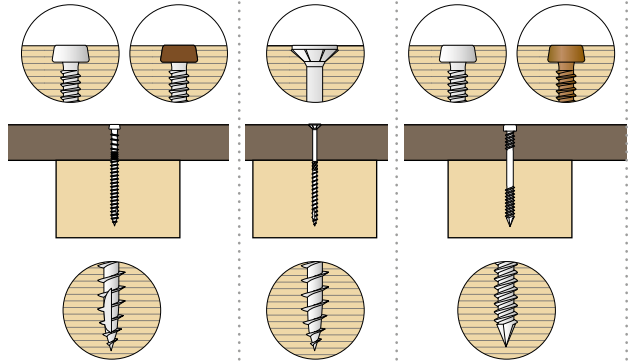

LEGEND:

- installation without pre-drilled hole
- Ⓢ installation with pre-drilled hole

**EWS
A2 | AISI305**

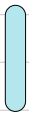
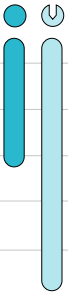
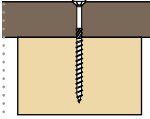

**SCI
A2 | AISI305
HBS EVO**

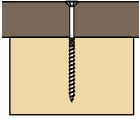
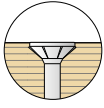

KKZ C5 EVO

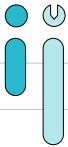
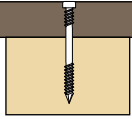
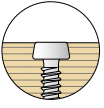

**EWS
AISI410**

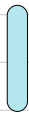
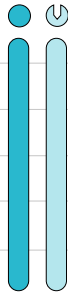
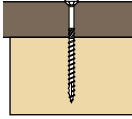

**KKF
AISI410**

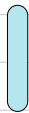
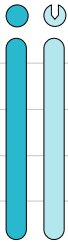
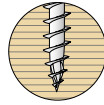
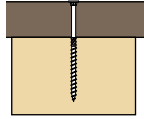
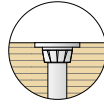

KKT COLOR

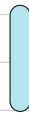
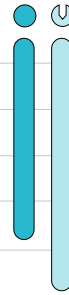
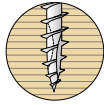
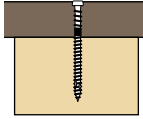
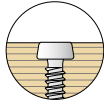

Decking screws are considered ($\varnothing \leq 6 \text{ mm} - 0.24 \text{ in}$)

CONNECTORS FOR HYBRID CONNECTIONS

WASHER AND METAL-TO-TIMBER



HUS



VGU



Certified washers for screws with counter-sunk heads.

CONCRETE-TO-TIMBER



CTC

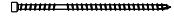

Certified connector for concrete-timber composite systems, calculation software available.

SOFTWOOD-HARDWOOD



HBS HARDWOOD

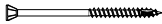

Certified screw for hybrid connections between softwood and BeechLVL elements.

SOFTWOOD-HARDWOOD



VGZ HARDWOOD

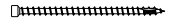

Certified screw for hybrid connections between softwood and BeechLVL elements.

TIMBER-TO-METAL

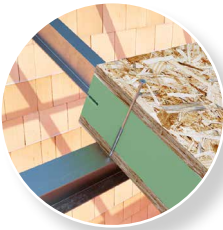

SBS-SPP



Self-drilling screw for fastening timber elements and panels to metal substructures up to 10 mm thick.

TIMBER-INSULATION LAYER-TIMBER

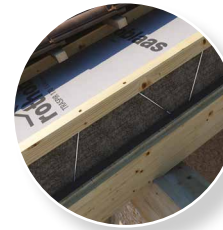

DGZ



Fastening system for rigid or soft insulation installed on roofs or walls.

TIMBER-TO-METAL-TO-TIMBER



SBD - SBD EVO

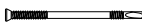

Self-drilling dowel - allows drilling of metal plates up to 10 mm (3/8 in) thick.



SBS-SPP

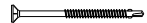

Ideal for fastening timber-to-metal-to-timber composite ceiling systems with trapezoidal sheet metal.

MATERIALS

Until 200 years ago, timber was the most commonly used material for construction; it was later replaced by steel and concrete. Timber as a "building material" has evolved over the last 100 years with the introduction of engineered wood products (GLT, CLT and LVL).

Two macro-categories are distinguished: softwoods and hardwoods.

LEGEND:

structural
SOFTWOOD

structural
HARDWOOD

Solid timber



GLT

Glued Laminated Timber



CLT

Cross Laminated Timber



LVL

Laminated Veneer Lumber



OSB

Oriented Strand Board



Decking

Decking boards

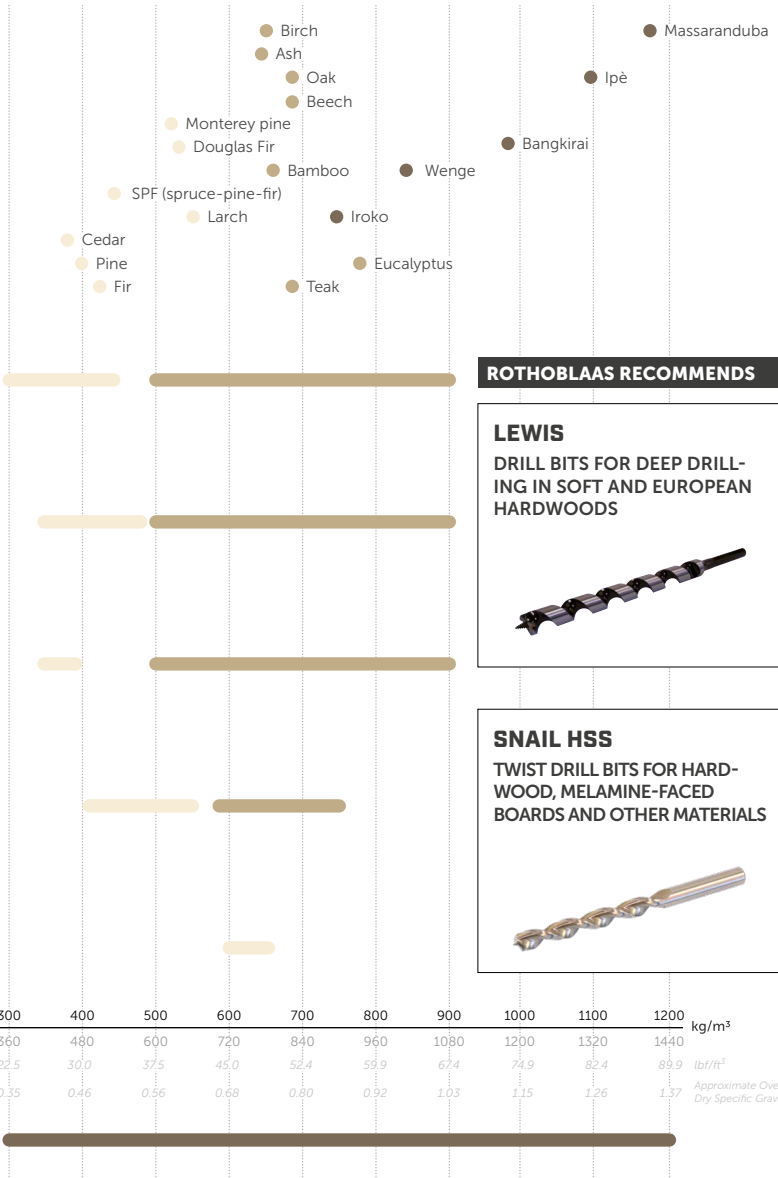

ROTHOBLAAS RECOMMENDS

LEWIS

DRILL BITS FOR DEEP DRILLING IN SOFT AND EUROPEAN HARDWOODS



SNAIL HSS

TWIST DRILL BITS FOR HARDWOOD, MELAMINE-FACED BOARDS AND OTHER MATERIALS





How to install
correctly?

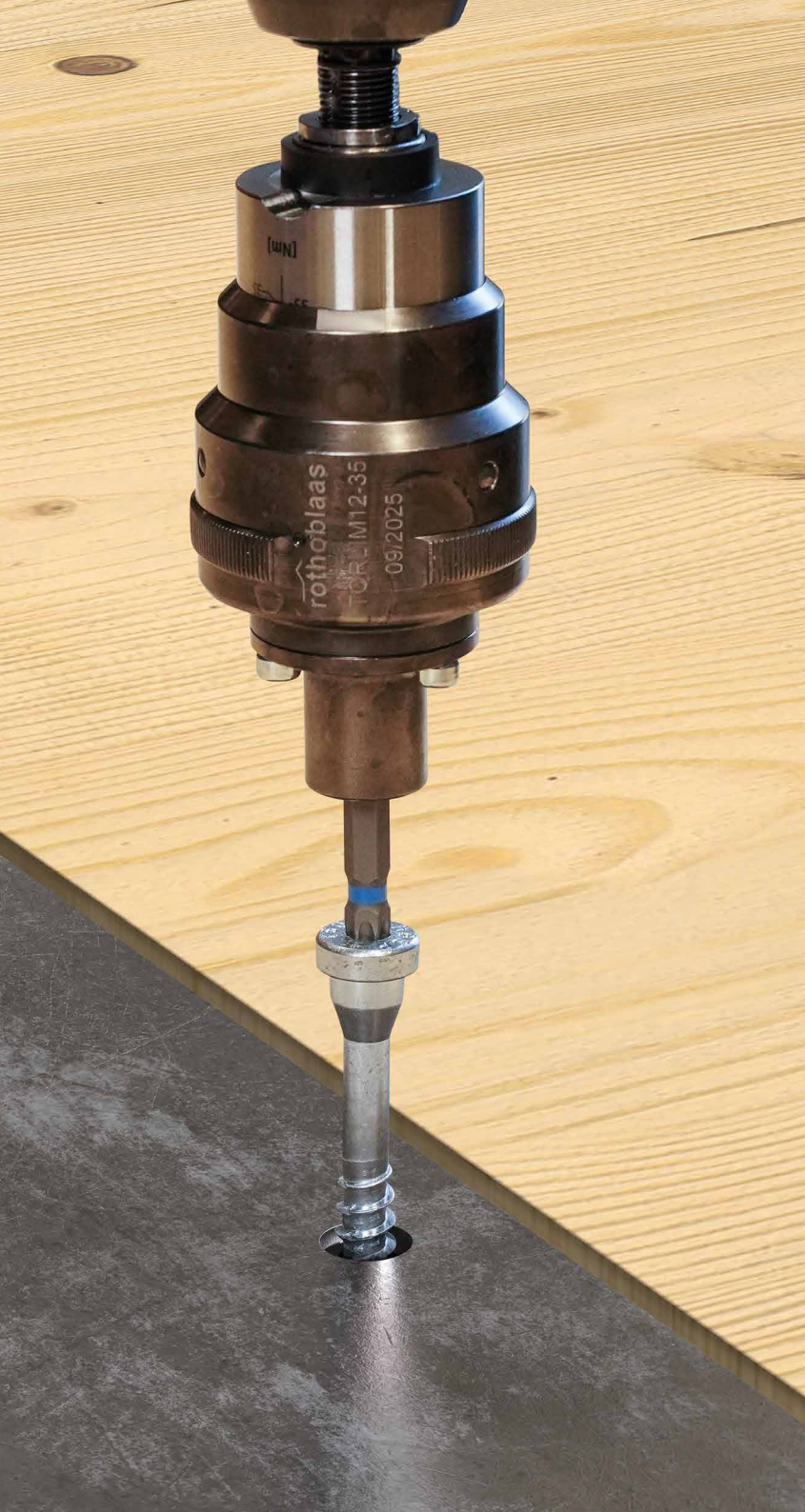

PRACTICAL

MINIMUM DISTANCES AND PRE-DRILL

MINIMUM SPACING AND DISTANCES

The positioning of the screws within the timber element must take into account the interaction between the two elements.

The use of adequate spacing and minimum spacing between screws avoids splitting of the timber element and brittle connection failure mechanisms.

insufficient spacing between screws

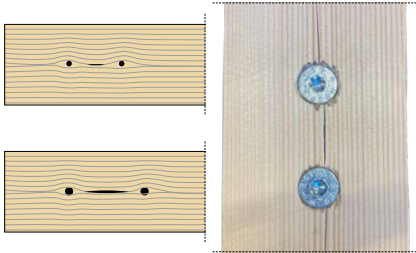

inadequate edge and end distances

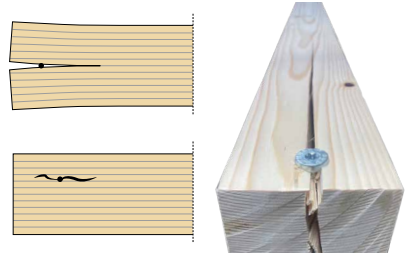

MINIMUM DISTANCES AND SPACING REQUIREMENTS for screws, with and without pre-drilled holes and on different materials, available in the "Screws and connectors for timber" catalogue www.rothoblaas.com



PRE-DRILL AND PILOT HOLE

A **pre-drilled hole** allows the screw to be installed with less resistance and minimises damage in the timber. Pre-drilling is carried out along the entire length of the screw. Installation with a pre-drilled hole generally allows for reduced spacing and minimum edge and end distances

● installation without pre-drilled hole

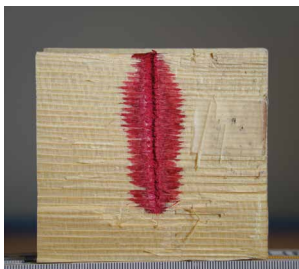

The portion of timber affected by the insertion of the screw is greater in the case of no pre-drilling.

☺ installation with pre-drilled hole



Screws can be placed at a reduced distance because they are not affected by the interaction with each other.

Pilot holes or guide holes are used to facilitate the insertion of screws.

They have limited length (usually 40-80 mm *1.5-3 in*).

They are recommended when installing long screws or when a very precise insertion angle is required.

PRE-DRILL HOLE DIAMETER

The **size of the pre-drilled hole** depends on the geometry of the screw and the type of wood on which it is to be installed (for more specific information on materials, see page 55).

$d_{v,rec}$ the recommended pre-drill hole diameter
 d_v the pre-drill hole diameter

SOFTWOOD

d_2 the internal thread diameter
 d_1 the nominal diameter

$$d_v \leq d_2$$

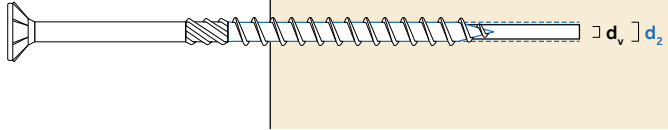

d_1	[mm]	3	3,5	4	4,5	5	5,3	5,6	6	7	8	9	10	11	12	13	16	20
	[in]	0.12	0.14	0.16	0.18	0.20	0.21	0.23	0.24	0.28	0.32	0.36	0.40	0.44	0.48	0.52	0.63	0.79
$d_{v,rec}^{(1)}$	[mm]	2	2	2,5	2,5	3	3,5	3,5	4	4	5	5	6	6	7	8	13	16
	[in]	5/64	5/64	3/32	3/32	1/8	9/64	9/64	5/32	5/32	13/64	13/64	15/64	15/64	9/32	5/16	1/2	5/8

HARDWOOD

d_s the shank diameter
 d_1 the nominal diameter
 d_2 the internal thread diameter

$$d_s \geq d_v \geq d_2$$

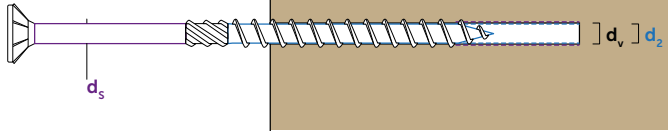

d_1	[mm]	3	3,5	4	4,5	5	5,3	5,6	6	7	8	9	10	11	12	13	16	20
	[in]	0.12	0.14	0.16	0.18	0.20	0.21	0.23	0.24	0.28	0.32	0.36	0.40	0.44	0.48	0.52	0.63	0.79
$d_{v,rec}^{(1)}$	[mm]	-	-	-	-	3,5	4	4	4	5	6	6	7	7	8	9	-	-
	[in]	-	-	-	-	9/64	5/32	5/32	5/32	13/64	15/64	15/64	9/32	9/32	5/16	3/8	-	-

THE IMPORTANCE OF CORRECT PRE-DRILL

⚠ $d_v < d_{v,rec}$
 failure

The force on the screw during insertion exceeds the torsional resistance of the screw.

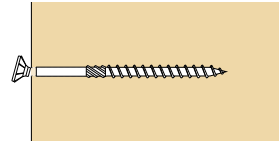

⚠ $d_v > d_{v,rec}$
 $F_{ax} \ll$

A portion of the thread is not in contact with the wood; the withdrawal resistance decreases.

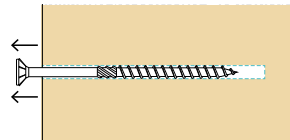

⁽¹⁾ ETA-11/0030.

INSERTION MOMENT

To penetrate timber, the screw must overcome its resistance force.

The force during installation (torsional insertion moment - R_{tor}) is related to the geometry of the fastener and the material of the support. To avoid breakage, the force on the screw must not equal or exceed its intrinsic torsion resistance (f_{tor}). According to the European standard⁽¹⁾, a minimum screwing torsion ratio of 1,50 ($f_{tor,k} / R_{tor,mean} \geq 1,5$) must be ensured.

The graphs below show the development of the insertion moment for screws applied under different conditions, both in terms of the timber used and the type of pre-drill.

insertion type A
WITHOUT pre-drilled hole
(LV = 0 mm)



insertion type B
WITH pre-drilled hole
of length LV = L/2

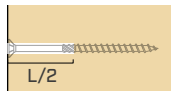

insertion type C
WITH pre-drilled hole
of length LV = L

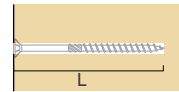

SOFTWOOD

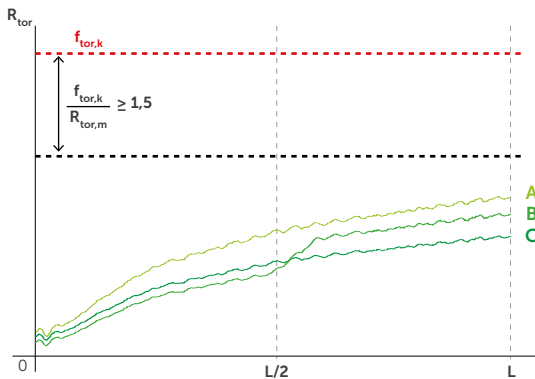

The installation of screws in wood with relatively low density can also be achieved without a pre-drilling hole.

The force on the screw remains below the torsional limit [A-B-C].

The use of a pilot hole facilitates installation and ensures that the screw is oriented in the right direction and angle.

HARDWOOD

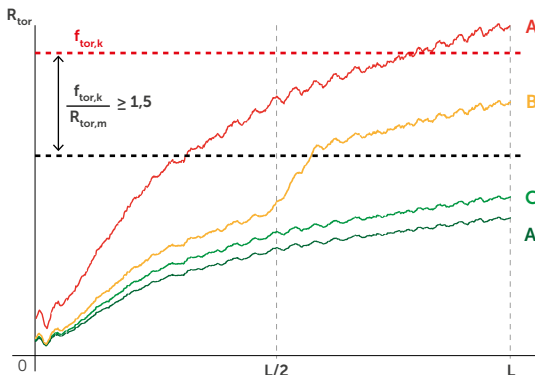

“Standard” screws require a pre-drilled hole [C] in order to be installed in hard wood; otherwise, there is a risk of breakage [A].

Partial length pre-drilled holes [B] reduce the insertion moment on the screw but does not preclude the possibility of breakage.

Screws with specific geometry for hardwood (HARDWOOD screws) can be installed without pre-drilling holes [A^H].

⁽¹⁾ EN 14592:2022 | EAD 130118-01-0603

IMPULSE and IMPACT : YES or NO?

Rothoblaas carried out an experimental campaign in cooperation with the University of Innsbruck to evaluate the influence of the use of different screwdrivers on the mechanical properties of screws (e.g. tensile strength) and the insertion moment.

TESTED SCREWS

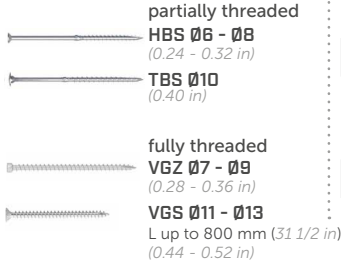

MATERIALS



SCREWDRIVERS



TENSILE STRENGTH

The steel tensile strengths of new, unused screws (reference samples) were compared with screws installed in timber (inserted and then extracted with different screwdrivers).

The tensile strength is not dependent on the type of driver used during installation: as shown in the graph to the right, the differences, less than 2%, are presumably related to the intrinsic variability of the timber elements used and not to the screwdriver used.

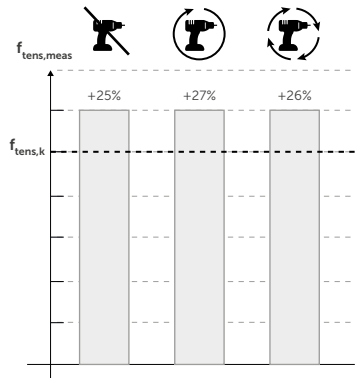
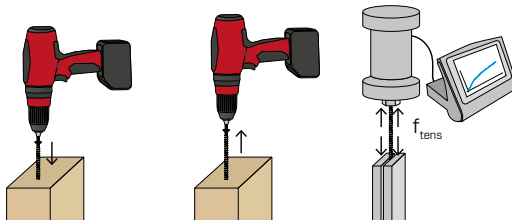

INSERTION MOMENT

The use of an impact screwdriver/pulse screw gun did not cause any substantial change in insertion resistance compared to installation with a "standard" screwdriver. The characteristic torsion ratio ($f_{tor,k} / R_{tor,MW}$) remained below the torsional limits of the standard.

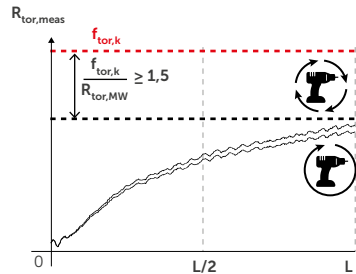
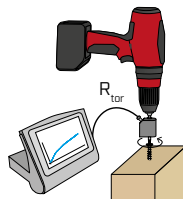

ACCREDITED TEST REPORT (202011-0088) "Influence on the tension strength of screws type HBS, TBS, VGS and VGZ by the use of different screw-in devices" available on www.rothoblaas.com



TIMBER-TO-TIMBER CONNECTION



In the case of screws used in timber-to-timber (softwood) structural connections, a pulse screw gun/screw driver can also be used for installation.

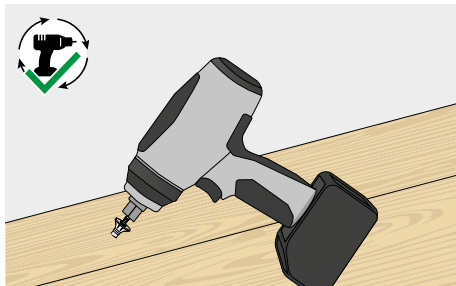
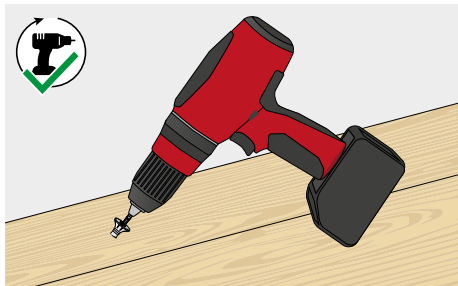

Proper installation ensures structural performance and relative strength of partially or fully threaded self-drilling screws in timber-to-timber and metal-to-timber connections.

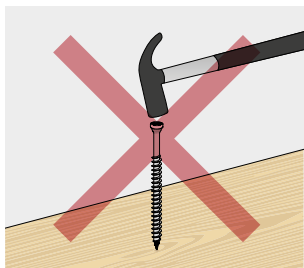

Do not hammer the screw tips into the timber.

The screw cannot be reused.

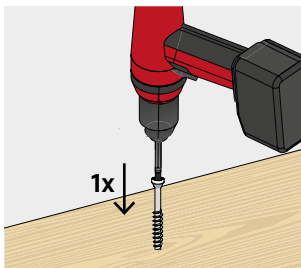

In general, it is recommended to insert the connector in one operation, without making stops and starts that could create overstressing states in the screw.

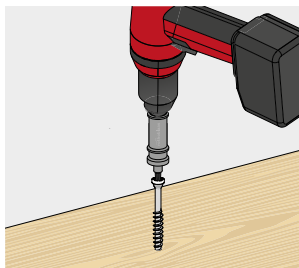

Select the appropriate size and type of bit. Rothblaas CATCH or CATCHL screw holder can be used to ensure that the bit remains in the screw head recess during installation.

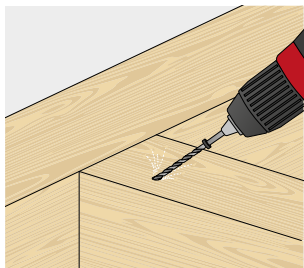

A pilot hole is recommended to ensure the correct installation direction.

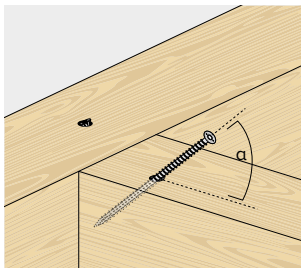

Respect the insertion angle.

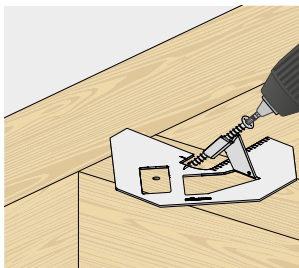

It is recommended to use the JIG VGZ 45° installation template.

METAL-TO-TIMBER CONNECTION



The screw must not be subjected to extreme stress and therefore must not come into contact with the plate in an abrupt manner which can lead to breakage even after installation.

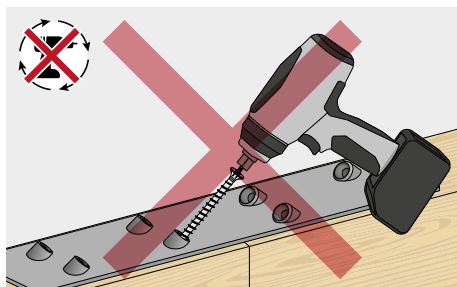
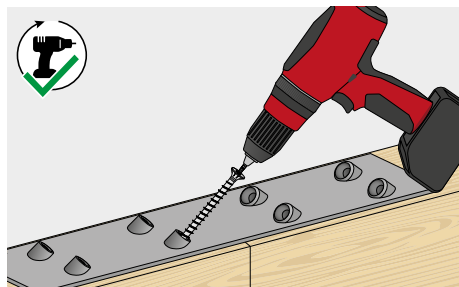

With an impact screwdriver/pulse screw gun, it is difficult to determine the precise stopping point. The screw is not continuously stressed, which is why the use of the impact screwdriver/pulse screw gun is not recommended.

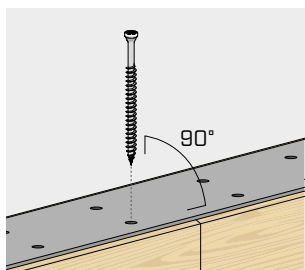

Respect the insertion angle.

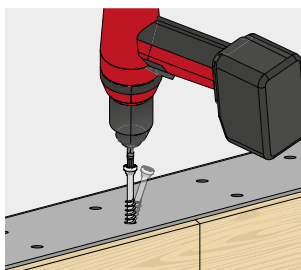

Avoid bending.

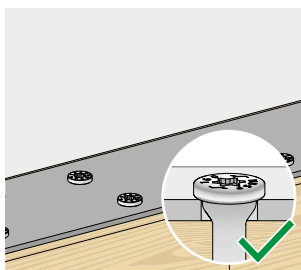

Ensure full contact between the entire surface of the screw head and the metal element.

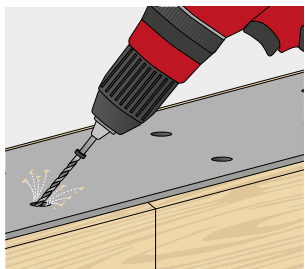

A pilot hole is recommended to ensure the correct installation direction.

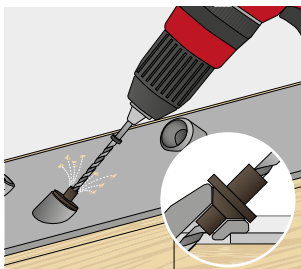

We recommend the use of the VGU JIG template in combination with the VGU washer.

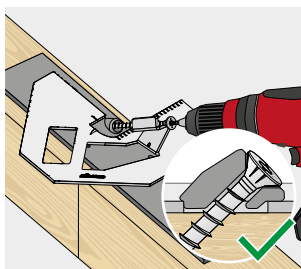

It is recommended to use the JIG VGZ 45° installation template.

METAL-TO-TIMBER CONNECTION



INSTALLATION REQUIREMENTS

CONDITIONS OF USE

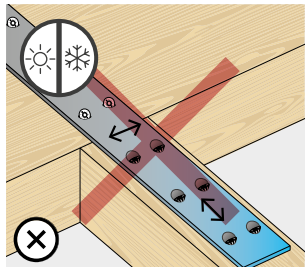

Avoid dimensional changes in the metal, e.g. due to large temperature fluctuations.

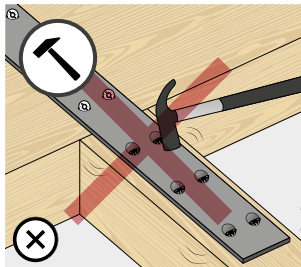

Avoid accidental stress during installation.

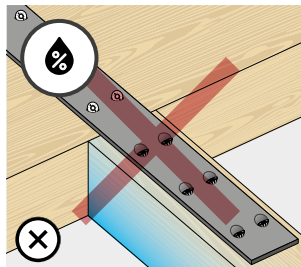

Shrinkage or swelling of timber elements due to changes in moisture content must be avoided.

INSERTION

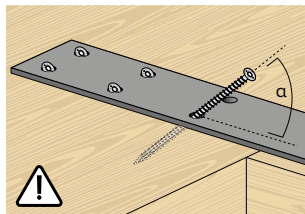

Respect the insertion angle.

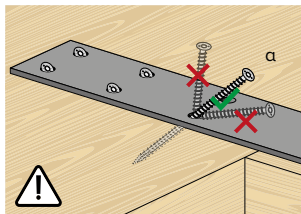

Avoid bending.

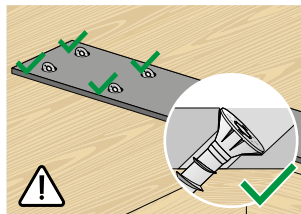

The installation of multiple screws must be performed to guarantee that loads are distributed evenly to all fasteners.

TIGHTENING

Use standard screwdrivers and to ensure correct tightening by using a torque wrench or to use torque-controlled screwdrivers in order to avoid prestressing screw heads.

Recommended tightening torque values:

	VGS Ø9 (0.36 in)	VGS Ø11 (0.44 in)	VGS Ø11 (0.44 in)	VGS Ø13 (0.52 in)
	L < 400 mm		L ≥ 400 mm	
	L < 15 3/4 in		L > 15 3/4 in	
M_{ins} [Nm]	20	30	40	50
[ft-lbs]	15	22	30	37
	HBS PL Ø8 (0.32 in)	HBS PL Ø10 (0.40 in)	HBS PL Ø12 (0.48 in)	
M_{ins} [Nm]	25	35	50	
[ft-lbs]	18	25	36	

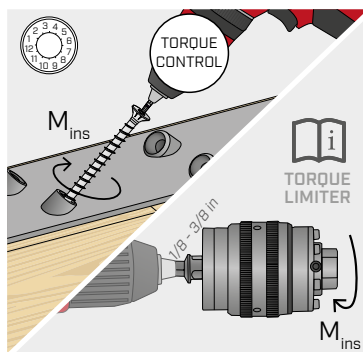

FINISHES

Ensuring full contact between the underside of the screw head and the metal element.

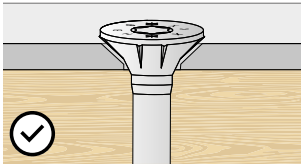

Countersunk hole.

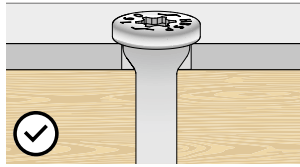

Cylindrical hole.

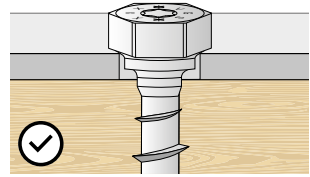

Cylindrical hole.

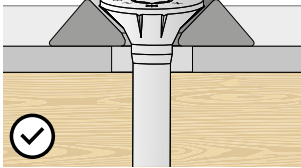

Flared washer.

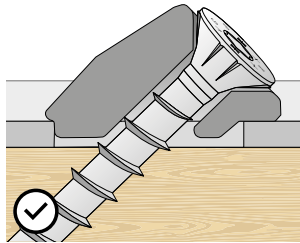

VGU inclined washer

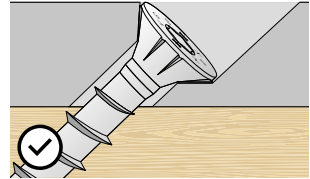

Inclined countersunk hole



PARTICULAR CONSIDERATION SHOULD BE GIVEN TO

Due to the installation angle, a large head is critical in metal-to-timber applications. Limited or incorrect contact between the metal element and the screw head can lead to localized prestressing resulting in reduced connection capacity or localised screw failure.

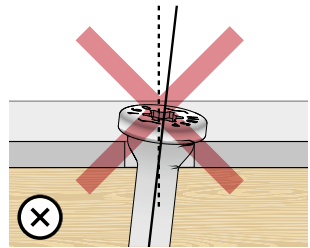
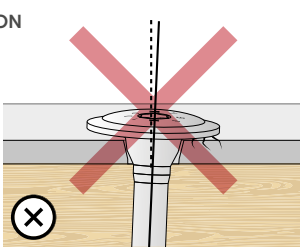
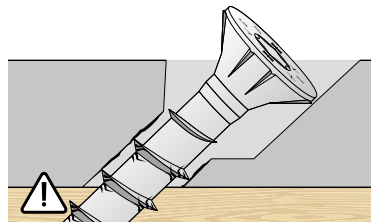

PLATE HOLES

The diameter of a hole in a metal plate must always be larger than the outer diameter of the screw, in order to prevent the thread from being damaged during installation and the connector from not performing as intended.

Ensure that the screw threads do not come into contact with the metal element during insertion.



CONSTRUCTION PRESCRIPTIONS: DECKING

Attention to detail guarantees the durability, aesthetics and stability of the decking. It also helps prevent of problems related to rot, cracks or deformation.

DISTANCE BETWEEN BOARDS

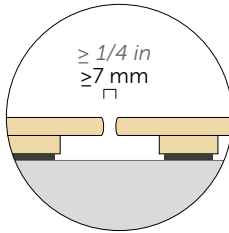
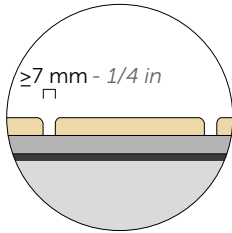

- allow for the wood to move
- avoid the accumulation of water or rot at the ends of the boards
- avoid accumulation of dirt

UNDERBOARD VENTILATION

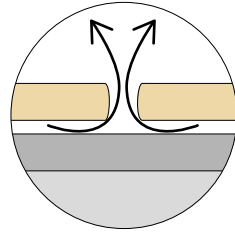

- avoid the accumulation of water and moisture
- allow for the wood to move
- avoid direct contact between the board and supporting structure

FASTENERS CHOICE

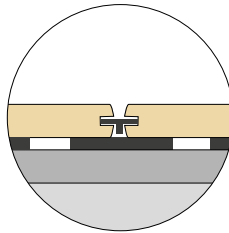
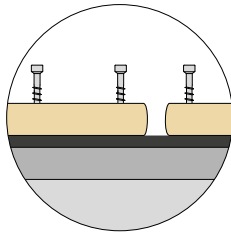

- meet appearance requirements
- visible or hidden fastening

POSITIONING OF FASTENINGS

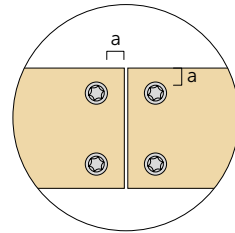

- avoid cracking of the boards
- ensure permanent fixture

LOAD CARRYING CAPACITY OF THE DECKING

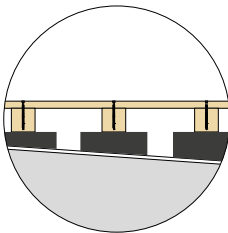

- guarantee safety and stability
- plan for an appropriate spacing between the substructure elements 40÷60 cm (16 in-24 in)
- verify that the substructure is level
- use the same material for the decking and substructure

EDGE DISTANCE

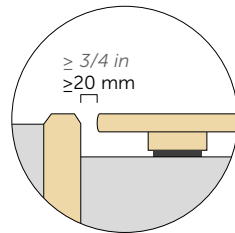

- allow for the wood to move
- avoid standing water
- avoid the localised accumulation of moisture in the wood
- avoid accumulation of dirt

Proper selection of a wood species and decking quality on the basis of the design requirements can avoid shrinkage, swelling, various deformations between elements and warping. These problems can compromise the proper functioning of the fastening system.

*Terraces:
choosing the right
screw and installation
instructions*

TIME OF CONSTRUCTION



3 YEARS LATER

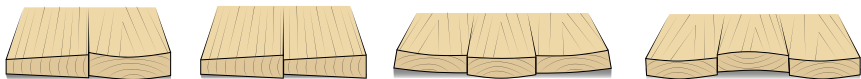

ROTHOBLAAS RECOMMENDS



DRILL STOP
SET OF DRILL BITS AND
COUNTERBORE CUTTER WITH
SWIVEL DEPTH STOP



**BROAD
COUNTERBORE CUTTER**
FOR KKT, KKZ, KKA

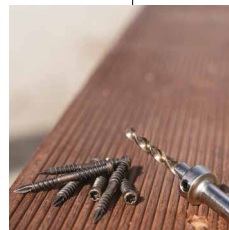

CRAB MAXI
BOARD CLAMP

- ▶ Swivel handle for precise adjustments
- ▶ To tension from 5 to 7 boards together
- ▶ Opening from 200 to 770 mm (8 to 30 in)

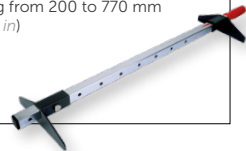

STAR
STAR FOR DISTANCES

- ▶ The 5 most common dimensions in a single tool
- ▶ Creation of uniformly sized joints
- ▶ Thickness from 4 to 8 mm (3/16 to 5/16 in)

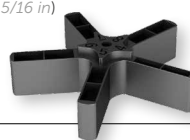

OUTDOOR, everything you need to design and build outdoor environments. Discover the outdoor guide on our website or request the catalogue from your agent. www.rothoblaas.com



CONSTRUCTION REQUIREMENTS: WORKSITE

During transport, storage and assembly, wooden elements must be protected to minimise their changes in moisture content.

CONSTRUCTION PHASE: construction in progress

When installed, timber elements have moisture contents compatible with those of the factory in which they were manufactured.

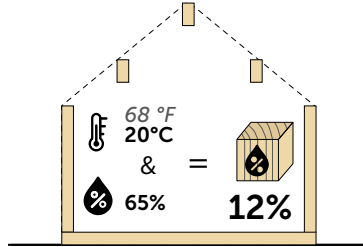

INTERMEDIATE PHASE: construction site is exposed to the weather

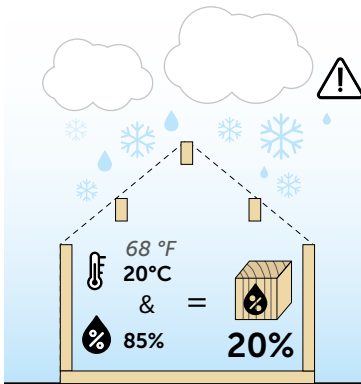

without protection

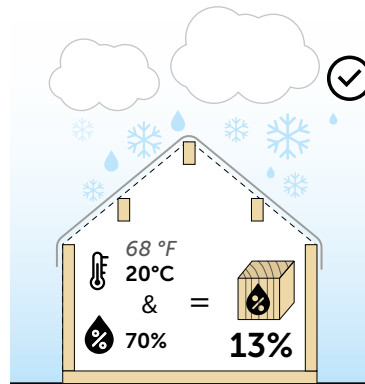

with protection

If it is not properly protected, in the event of rain, the increase in humidity in the air leads to a considerable increase in moisture content in the wooden elements.

FINISHED WORK: construction completed

Timber elements are in moisture equilibrium with the final environmental conditions. Protecting the structure from weather, especially the joints, during the construction phase ensures structural performance as designed.

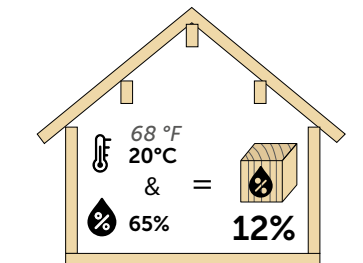

*Construction site: best practice
for moisture management*

ROTHOBLAAS RECOMMENDS

CAP TOP TARPAULIN FOR ROOFS



- ▶ Each size is equipped with a reinforced lifting hook for easier installation.
- ▶ Thanks to the metal fastening eyelets every metre, it is possible to fix the tarpaulin to the roof.
- ▶ The large mass per unit area and the type of material guarantee better mechanical resistance and durability over time.
- ▶ When fixing the tarpaulin to the roof it is important that all eyelets are always anchored so that the wind load is spread over as many eyelets as possible.



TRASPIR ADHESIVE 260 HIGHLY BREATHABLE SELF-ADHESIVE MEMBRANE



- ▶ **SELF-ADHESIVE**
Thanks to the new generation glue, the membrane ensures good adhesion even on rough OSB.
- ▶ **SECURE SEALING**
The adhesive surface prevents the formation of airflow behind the membrane in case of accidental breakage or failure to seal.
- ▶ **BREATHABLE**
Thanks to the patented glue, the membrane remains perfectly breathable even when fully bonded.



BYTUM SLATE 3500 SELF-ADHESIVE SLATED BITUMINOUS MEMBRANE



- ▶ **EASY INSTALLATION**
The slate finish makes BYTUM SLATE 3500 usable on slopes up to 5° as an under-tile and compatible with mortar and foam.
- ▶ **WIDE RANGE**
Available in 4 colours to meet different application areas and aesthetic requirements.
- ▶ **FLEXIBILITY**
Flexibility and workability are guaranteed even at low temperatures thanks to the polymer-modified bituminous compound.



SCREWDRIVERS

What is the right
screwdriver for my
screws?

The choice of a screw or drill driver depends on the type and size of the screw, the application and the type of material.

SMALL SCREWS | $\varnothing 3,5\text{-}\varnothing 10$ mm (0.14 - 0.40 in)



- Universal use for multiple applications
- Ideal for construction site use with battery-powered system
- Switchable percussion function and adjustment of maximum torque level for precise work

ROTHOBLAAS RECOMMENDS

ASB 18

2-SPEED CORDLESS DRILL DRIVER



LARGE SCREWS | $\varnothing 8\text{-}\varnothing 12$ mm (0.32 - 0.48 in)

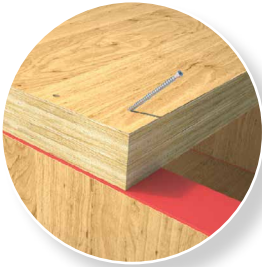

- Powerful drill driver for structural screws
- In first gear it allows the installation of connectors, including very long ones
- In second gear (high speed) it allows the drilling of both timber and steel elements

ROTHOBLAAS RECOMMENDS

B 13 B

2-SPEED DRILL DRIVER



CONNECTORS | $\varnothing 11\text{-}\varnothing 20$ (0.44 - 0.79 in)



- Powerful and robust 2000W motor with right/left rotation for very high torque output in 1st gear (> 250 Nm- 184 lbf-ft)
- With the use of appropriate adaptors, it allows the installation of threaded rods or very long screws in timber

ROTHOBLAAS RECOMMENDS

D 38 RLE

4-SPEED DRILL DRIVER



TOOLS AND MACHINES, everything you need to work in best conditions on site. Discover them on our website or ask your trusted agent for the catalogue. www.rothoblaas.com



Rotho Blaas Srl does not guarantee the legal and/or design conformity of data and calculations, as Rotho Blaas provides indicative tools such as technical-commercial service within the sales activity.

Rotho Blaas Srl follows a policy of continuous development of its products, thereby reserving the right to modify their characteristics, technical specifications and other documentation without notice.

The user or the designer are responsible to verify, at each use, the conformity of the data to the regulations in force and to the project. The ultimate responsibility for choosing the appropriate product for a specific application lies with the user/designer.

The values resulting from "experimental investigations" are based on the actual test results and valid only for the test conditions specified.

Rotho Blaas Srl does not guarantee and in no case can be held responsible for damages, losses and costs or other consequences, for any reason (warranty for defects, warranty for malfunction, product or legal responsibility, etc.) deriving from the use or inability to use the products for any purpose; from non-conforming use of the product;

Rotho Blaas Srl is not liable in any way for any errors in printing and/or typing. In the event of differences between the contents of the catalogue versions in the various languages, the Italian text is binding and takes precedence with respect to the translations.

Pictures are partially completed with accessories not included. Images are for illustration purposes only. Packaged quantities may vary.

This catalogue is private property of Rotho Blaas Srl and may not be copied, reproduced or published, totally or in part, without prior written consent. All violations will be prosecuted according to law.

The general purchase conditions of Rotho Blaas Srl are available on the website www.rothoblaas.com.

All rights reserved.

Copyright © 2025 by Rotho Blaas Srl

All renderings © Rotho Blaas Srl

Rotho Blaas Srl

Via dell'Adige N.2/1 | 39040, Cortaccia (BZ) | Italia
Tel: +39 0471 81 84 00 | Fax: +39 0471 81 84 84
info@rothoblaas.com | www.rothoblaas.com

